

ISTI News

The biannual magazine of the Institute of Information Science and Technologies "A. Faedo"

ISSUE 12

December 2022

ISSN 2724-6566 DOI: 10.32079/ISTInews © Institute of Information Science and Technologies "Alessandro Faedo"

Cover Story
Architectural
Geometry

EDITORIAL
PNRR Recovery Plan
Opportunities and risks for Italian
institutions

Contents

Editorial

PNRR Recovery Plan 3

Cover Story

Architectural Geometry 6

New Projects

SUN 10

SoBigData RI PPP 11

CODECS 12

Tuscany X.0 12

FAIRCORE4EOSC 13

Skills4EOSC 14

LODLNB 15

Selected Papers

A path-aware scheduler for Air-to-ground multipath multimedia delivery in real time 16

Evaluation of angle of arrival in indoor environments with bluetooth 5.1 direction finding. 17

Systematic evaluation and usability analysis of formal methods tools for railway signaling system design. 18

Static detection of equivalent mutants in real-time model-based mutation testing: an empirical evaluation. 18

Geometric model checking of continuous space 19

How do requirements evolve during elicitation? An empirical study combining interviews and app store analysis. 20

Solution bundles of Markov performability models through adaptive cross approximation 21

Linking different scientific digital libraries in Digital Humanities: the IMAGO case study 22

The transparency of automatic web accessibility evaluation tools: design criteria, state of the art, and user perception 23

End-user development in industrial contexts: the paper mill case study. 24

Filling gaps in trawl surveys at sea through spatiotemporal and environmental mod 25

Habitat distribution change of commercial species in the Adriatic Sea during the COVID-19 pandemic 26

The potential effects of COVID-19 lockdown and the following restrictions on the status of eight target stocks in the Adriatic Sea 27

Tweet sentiment quantification: an experimental re-evaluation 28

Where do migrants and natives belong in a community: a Twitter case study and privacy risk analysis 29

Generating mobility networks with generative adversarial networks. 30

The Istella22 dataset: bridging traditional and neural learning to rank evaluation 31

Caching historical embeddings in conversational search. 32

Improving plant disease classification by adaptive minimal ensembling. 33

WordMelodies: supporting the acquisition of literacy skills by children with visual impairment through a mobile app. 34

Ambient Assisted Living: a scoping review of artificial intelligence models, domains, technology and concerns 35

SkinMixer: blending 3D animated models 36

Vorogrid: a static-aware variable-density Voronoi mesh to design the tube structure tessellation of tall buildings 37

The influence of deflections on the static and dynamic behaviour of masonry columns. 38

A semidefinite programming approach for the projection onto the cone of negative semidefinite symmetric tensors with applications to solid mechanics 38

Using the space debris flux to assess the criticality of the environment in low Earth orbit 39

Software&Tools

CATLIB 40

FTS4VMC. 41

Awards and Achievements

Cor Baayen Young Researcher Award 2022 42

Best Ph.D. Forum paper award at PerCom Conference

New Chair of the IADC Working Group on Environment and Data Base. 43

New IAA Full Member 43

IAA Academy Day 44

The blind prediction challenge within the framework of the SERA project 44

Young Researcher award “Matteo Dellepiane” 2022. 45

Grants for Young Mobility 46

PNRR Recovery Plan

Opportunities and risks for Italian institutions

NextGenerationEU is the European response to the negative effects of the COVID-19 pandemic. As part of this plan, the Recovery and Resilience Facility aims at fighting the economic and social effects of the long lock-down period and thus contributing to the subsequent economic recovery and sustainable development of EU states. The plan was perceived as a milestone opportunity to attack and hopefully solve some of our major social and economic weaknesses. However, the EC wisely demanded that the nation states back up requests for financial assistance (major investments, via either grants or loans) with clear programs for structural reform. Each nation state was asked to produce a list of reforms, intended as a set of mandatory and monitored conditions for participation.

The Recovery Plan is of crucial importance for Italy as it will contribute to the much-needed modernization of our key infrastructures and our public administration. The imposition of a strong commitment to the design and implementation of structural reform is a welcome measure as it will help to break resistance to innovation and will encourage the timely implementation of new, more effective, public rules and regulations.

The implementation of the Recovery Plan, in Italy known as the “Piano Nazionale di Ripresa e Resilienza” (PNRR, National Plan for Recovery and Resilience), is now under way. Research and Innovation is a clear focus of this Plan. Here below we give our first impressions as to how it will impact the research institutions.

The PNRR in Italy - Focusing on Research and Innovation

The PNRR is focused in two main directions: structural reform and innovation. The government led by Mario Draghi programmed a wide set of interventions in this respect, and these included a proposal for the restructur-

ing of CNR. This was followed by an intense year-long discussion between the governing bodies of CNR and the Ministry for the Universities and Research (MUR). The aim was to create the conditions for an extensive and comprehensive reform of our institution. This process was coordinated by the president of CNR, Maria Chiara Carrozza, who requested the Board of Directors of the Institutes to indicate the main problems and suggest solutions. The consultation was fervent and several working groups were set up; members included key managers of the CNR head offices in Rome as well directors of the Institutes. The results formed the basis for the CNR Recovery Plan (*Piano di Rilancio CNR*), which was submitted to the Ministry in June 2022, and positively evaluated by the government.

Unfortunately, the fall of the government and subsequent elections in October 2022 has created some delay in the implementation of the CNR Recovery Plan, especially with respect to the accompanying financial measures requested. The initial proposal included an increase in the annual state budget of CNR. This was particularly important as it represented the necessary precondition for the recruitment of new administrative and technical staff, which has been blocked for many years. The result is that, although CNR is currently in the midst of an important reform, it is still unclear whether this reform will be backed up by an essential increase in public funding.

PNRR - ISTI Opportunities

ISTI participated successfully in many PNRR calls, contributing to all categories (National Centers – CN, Innovation Ecosystems – EI, Extended Partnerships – PE, Research Infrastructure – IR). The Institute is now active in 21 actions/spokes, listed in summary table on page 5.

PNRR projects will bring us important fi-

ancial resources, totaling for each call category: CN 1,6 ME; EI 1,4 ME; PE 2,7 ME; IR 9,5 ME; with a grand total of 15,5 ME PNRR funds covering the time frame 2023-2025. This will approximately double the usual ISTI research budget.

These additional funds will allow us to advertise a good number of short-term research contracts (involving the need for rapid recruiting procedures) and will allow us to invest in infrastructure and equipment, thanks to the funds provided by the Research Infrastructures call. The latter is a major opportunity as the usual CNR budget does not offer resources for equipment. I am delighted that ISTI has been very successful in this direction; the proposals approved do not just involve much exciting research but will allow us to redesign the computing infrastructure of ISTI.

PNRR - Risks

PNRR requires the management of an unprecedented flow of research funds, assigned by MUR through competitive Calls for Proposals. This is a new development; until now state funding has been a very scarce resource for Italian research institutions (for example, in recent years ISTI has obtained 50-70% of its annual research budget through EC competitive Calls). Due to the pressure implied in launching multiple Calls and evaluating the proposals submitted with a very fast turnaround time, MUR has decided to announce Calls for extremely big projects (in the order of 100-200 ME each).

While there are research objectives which clearly require very high budgets (e.g., the design of a new airplane or new nuclear energy facilities), in many scientific domains highly funded projects, with very large consortia, have several potential drawbacks. There is a strong risk of generic, unfocused research programs with excessively complex

procedures both for management and for the integration of results.

However, although, at a first glance, the result of the PNRR MUR Calls gives this impression, I am confident that ISTI researchers will be able to exploit the opportunities offered. By taking advantage of the freedoms offered by the apparent lack of scientific focus of several of the approved projects in which they will participate, they are able to propose new lines of investigation without being unduly hindered by the restrictions of an overly tightly drawn research plan.

An important aspect of the EC Recovery Plan will be the careful monitoring of milestones and targets. Member states have to define their own set of milestones and targets, and the EC will then monitor and check the satisfactory fulfillment of these objectives. This is an important stimulus for the Italian system as we tend to be slow in implementation. Having deadlines and targets should help us in planning and achieving results but may prove problematic for our over-heavy state bureaucracy. The administration of CNR is not immune in this respect. A successful implementation of PNRR projects will require smarter and more efficient administrative regulations than those currently in force. This is worrying us.

Having to make important investments for the redesign of the ISTI computing infrastructure means that a lot of management and bureaucracy will be involved. We will

have to think not only about the design of the new computing center but also the management of European tenders for the construction of this center and the purchase of the new hardware resource. Moreover, thanks to the funds provided for the recruiting of young researchers, we will have to handle many recruitment committees within the same, very short time slot. The impact on the CNR and ISTI administrative staff will be considerable.

A number of times in the last year we have stressed the need to increase our administrative capabilities, both at the level of the Institute and of the head offices in Rome. Only at the end of November 2022 did CNR give us the go ahead to recruit more administrative staff (under a number of constraints). I hope this will not prove too late: the necessity to train new employees means that, at least for the first year, our participation in PNRR projects will have to be managed with our existing forces. It is clear that the next few months will involve much hard work for our administration.

A final issue is the ability of CNR to spend all the PNRR funds allotted in the time allowed. In this respect, the fragmentation of funding is a potential problem (the subdivision of funds among many tasks and partners implies that the funds assigned to a single CNR Institute on a single spoke might be insufficient to cover the expected costs for the entire duration of the project). We would need more flexibility of the spending rules. How-

ever, so far, no solution has been proposed.

We have noted that there are some similarities between perceived risks in the implementation of the PNRR plan for science and technologies in Italy with what is happening in other EU states. Similar top-down approaches have been reported by French colleagues, complaining about the very same issues.

Concluding remarks

The PNRR is a highly ambitious program, opening unprecedented opportunities for our country at large, and specifically for CNR. We must not waste this golden opportunity to reformulate and streamline CNR administrative procedures. But, above all, we must ensure that the funding obtained together with the intellectual freedom offered are fully exploited to produce excellence in research. This will always be our primary objective.

The future is in our hands – well not completely, as always politics will also have an important part. But, hopefully, the new Italian government will allow us to play a key role in designing the CNR of the future.

Contact: Roberto Scopigno, Director
direttore@isti.cnr.it



Finanziato
dall'Unione europea
NextGenerationEU



Ministero
dell'Università
e della Ricerca



Italiadomani
PIANO NAZIONALE
DI RIPRESA E RESILIENZA

ISTI participation to PNRR actions

- **CN 1 HPC** – Multimedia Retrieval, aiming at efficient similarity search with learned large-scale (out-of-core) indexing strategies; distributed Edge Learning, by adapting learning algorithms for distributed contexts using efficient information distribution strategies (Spoke 6).
- **CN 4 Sustainable Mobility MOST** – Development of communication infrastructures for 5G, Non-Terrestrial-Network (NTN) and Space-Air-to-Ground Infrastructures (SAGIN), study of transfer learning and federated learning with applications to mobility and IoT (Spoke 3); digitization of railway transport through the development of modelling and design methods for predictive monitoring and maintenance that contribute to resilient and sustainable railway infrastructure (spoke 4); design of a testbed for human-in-the-loop experiments in a virtual driving simulator for measuring the level of unconscious stress using visual and physical sensors and artificial intelligence (Spoke 6).
- **CN 5 Biodiversity NBFC** – Design computer vision systems to understand an environmental scenario of interest through the analysis of multisource data; develop a platform integrating this data; and implement a software application to promote the active involvement of the citizenry in environmental monitoring (Spoke 2).
- **EI Tuscany Health Ecosystem** – Customizable ecosystem for home monitoring or nursing home facilities, also providing additional support to general practitioners, integrating physiological, behavioral, cognitive, social and contextual data derived from commercial IoT devices, wearables, smartphone-embedded sensors, m-health systems producing heterogeneous health parameters related to frailty conditions (Spoke 3); dissemination and outreach (Spoke 5); research on bio-inspired artificial intelligence, specifically Hebbian learning and spike time-dependent plasticity (Spoke 8);
- **PE 1 AI FAIR** – Human-centered AI, research activities addressing the exploration of novel learning and reasoning approaches with the human-in-the-loop paradigm, to boost the adoption of AI-based trustworthy decision making systems, aware of the European ethical and legal frameworks (Spoke 1); defining new paradigms for understanding and reconstructing 3D data content, and investigating learning performance in biologically-inspired neural network models via self-organizing features and temporal complexity (Spoke8);
- **PE 5 CH CHANGES** – Designing a collaborative integrated web platform for assisting, recording and sharing the Cultural Heritage restoration process based on the use of 3D models and annotations (Spoke 5);
- **PE 7 Cyber Security SERICS** – Investigating methods and tools for: promoting security and privacy by design in the development lifecycle (Spoke 1); research on artificial intelligence methods for multimedia analysis to be used against misinformation (Spoke 2); security and privacy policies enforcement and testing (Spoke 8)
- **PE 8 Ageing AGE-IT** – Investigating a new generation of smart spaces in the multi-residence scenario, enriched with novel devices and AI tools to automatically detect adverse events and provide early risk prediction, managing dangerous situations and improving welfare (Spoke 9);
- **PE 11 Made in Italy 3A-ITALY** – Investigating solutions for supporting the design process in culture intensive industries, introducing advanced technologies for digitization of visual, physical, and mechanical characteristics of objects and data driven systems for style matching and popularity prediction (Spoke 1).
- **PE 14 Telecommunications RESTART** – Investigating methods and tools for drone control plan protocols, monitoring systems and contact tracing applications (Spoke 5); defining future integrated Terrestrial/Non-Terrestrial networks, where space network entities (UAV, aircraft, HAPs, and satellites) cooperate with terrestrial communication architectures to provide ubiquitous, resilient, and 3D wireless connectivity, with the support of AI (Spoke 11).

Research Infrastructures:

- **SoBigData** (Coordinator: ISTI) – Strengthen the Italian node of the European SoBigData research infrastructure (www.sobigdata.eu) studying the social complexity from big data and model-driven perspectives with a particular attention to ELSEC principles.
- **ITSERR** (Coordinator: ISTI) – Define research questions concerning the application of AI to the domain of religion science and provide related tools (in the framework of the RESILIENCE EC ERIC, www.resilience-ri.eu).
- **H2IOSC** – Develop new web services for online 3D presentation and processing, providing advanced features related to immersive VR/AR/MR, physically-based rendering, and digital fabrication.
- **FOSSR** - Support the creation of an Italian Open Science Cloud for the Social Sciences by delivering and operating a Virtual Research Environment (VRE), providing researchers with a web working environment where Open Science practices are transparently promoted.

Architectural Geometry

The development of computational tools and manufacturing techniques is continuously pushing forward the limit of feasible shapes in architecture. When dealing with new creative freeforms, issues arise concerning structural design, economic sustainability and, more generally, architectural style. Meeting these challenges requires a new approach to architectural design where form is driven by statics, manufacturing, material compliance, and other aspects that have implications on construction and cost, but are not disruptive to the creative aim.

Architectural Geometry (AG) is an interdisciplinary research field, introduced around 2007 to tackle some of the problems arising in the design of freeform structures. AG has its roots in classical and discrete differential geometry, and draws from different disciplines such as geometry processing, computer-aided design, structural engineering, and optimization. The main goal of AG is to find theoretical insights into the development of computational design tools that can assist architects in the smart design of freeform shapes that are compliant with the essential constraints of the architectural application (structural behaviour, fabrication problems, material availability, cost limitations).

Here at ISTI we have been pursuing these objectives for almost 10 years and are starting to tackle them from the perspective of large scale digital fabrication. Seminal works on computational fabrication have been developed at the Visual Computing Lab (VCLab), initially focusing on 3D printing applications. The experience matured within this research line led to new applications for large scale structures, which exploit and synthesize knowledge from the fields of computational geometry, shape analysis, numerical optimization, and physical simulation.

Within this vast and evolving cross-disciplinary field, computational methods become necessary to unlock novel architectural applications which are not feasible using manual design or traditional structural schemes.

Recently, we have broadened the focus of our research and have investigated multiple application scenarios within this domain.

Grid Shells

As described above, the scope of the challenges faced in AG is typically focused on freeform design. A prominent class of structures in freeform architecture are surface-like skins realized with cladding panels and supported by a framework. These structures are often referred to as grid shells. In grid

in which glass is used as a structural material. Given an input geometry, the algorithm automatically derives an optimal cable net, with respective pre-loads, that minimizes the tension on glass by post-tensioning the cables. In this way, only compression forces act on glass elements, which would otherwise break. By exploiting the glass as structural material, the section of steel rods can be reduced while still obtaining the same structural performances, thus providing enhanced visual appearance and lower steel usage (Fig. 1).

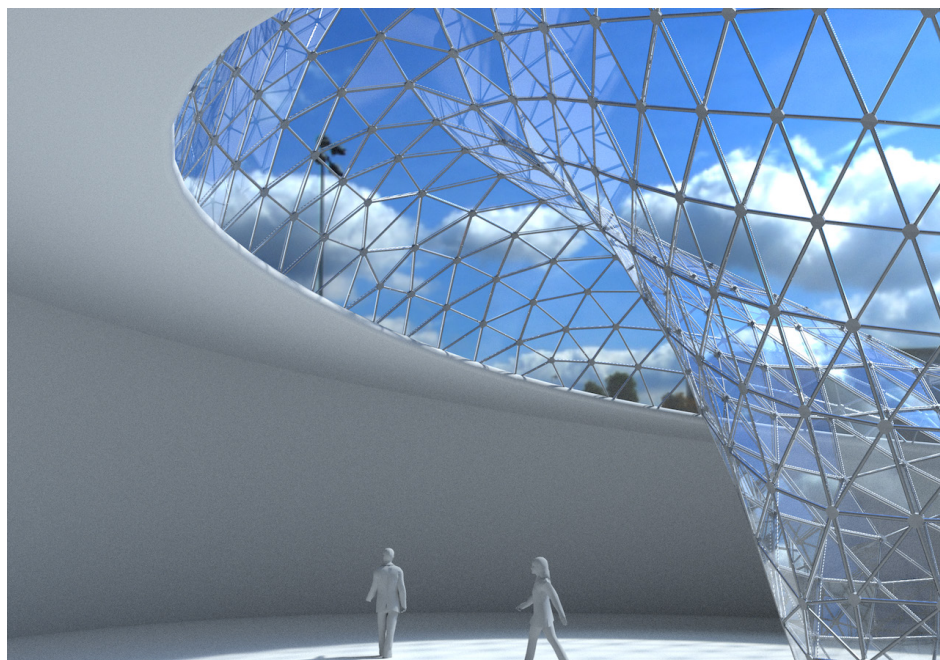

Fig 1. Example of a post-tensioned structural glass shell obtained from an automatic optimization method.

shells, the load bearing function is played by a grid of mono-dimensional elements (such as beams, rods and cables), which are spatially arranged to form a shell. The structures can be paneled with flat or curved facets, generally made of glass. The geometric complexity and low form repetitiveness of the building components of these structures, together with high static demand, entails elevated manufacturing costs. To reduce these costs, computational design tools (e.g., for geometric simplification, shape repetitiveness, and static optimization) are of prime importance. At ISTI we have developed a structural system and a method to design a special type of triangle-based grid shells

While triangular grid shells are easier to design, in many cases quadrilateral meshes used as grid shells are unbeatable for aesthetics, lightness and mechanical behaviour. However, enforcing the use of quads may cause alterations in the input shape. While extensive research is devoted to traditional quad/tri meshing, polygonal meshes can be used as an alternative, taking inspiration from lightweight and robust patterns that appear in nature. However, their topology makes the grid weaker from a structural perspective. Research work developed at the VCLab starts from an input surface and automatically generates a polygonal mesh that concentrates load-bearing material where

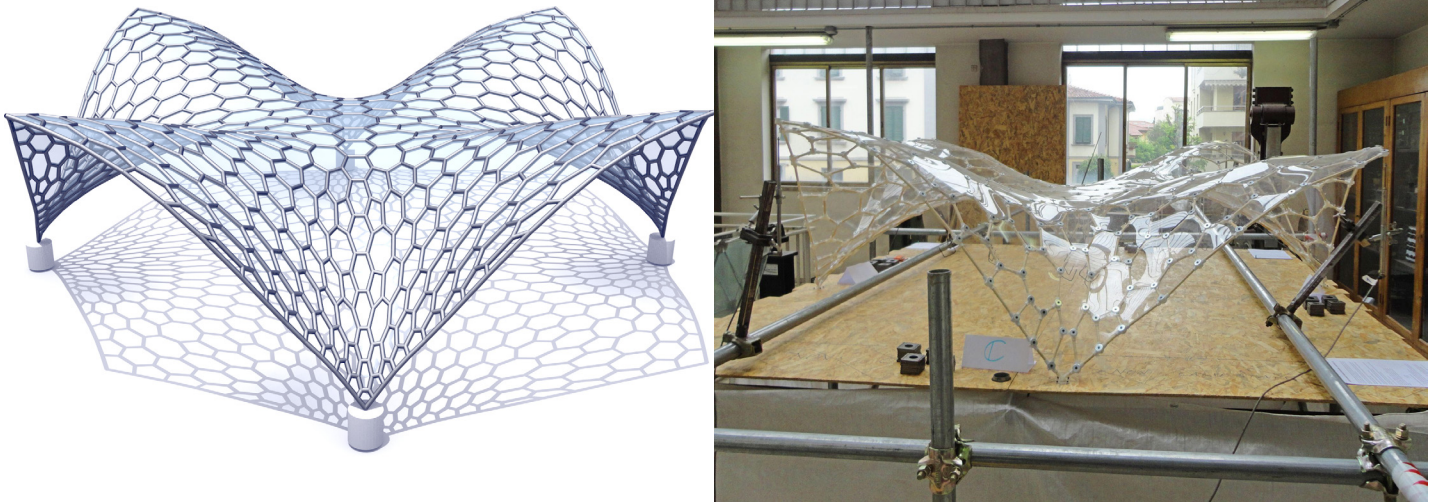

Fig 2. A statics-aware Voronoi grid shell and its small prototypal physical replica.



Fig 3. A high-rise Voronoi building and a detail of its structural skin elements.

the structure undergoes most stress, orienting the main elements along the principal stress directions of the underlying surface. The result is an anisotropic Voronoi mesh that has a distinctive organic appearance and achieves better performance than competitors (Fig. 2). A similar formulation has also been employed in a recent study on tall building skins having load-bearing purposes. This work adopts anisotropic Voronoi metrics conforming to known structural design

schemes to computationally generate the skin of high-rise buildings (Fig. 3).

Bending-active Structures

Grid shells are form-passive structures, in which the components, once assembled, can only be deformed by external loads. Instead, form-active structures, like bending-active structures, are shaped by the deformation of their components in the assembly phase, i.e.

due to bending. Although the components are cheap as they can be fabricated out of flat material, this scenario makes these structures hard to design. In fact, given an input design shape, there are only a few methods that automatically generate an optimized configuration of components that, once manufactured and deployed, can achieve the desired shape.

One example is FlexMaps, developed at the

VCLab. FlexMaps explores the concept of meta-material to produce challenging free-form bending-active shapes, using the geometry of spiral patterns to obtain a desired flexibility. This method automatically generates spiral-shaped patches which, once bent, assembled by hand and tied together, form the desired shape. It has been tested on large scale demonstrators such as The FlexMaps Pavilion, which is a non-developable twisted-shaped structure with a size of 3.90x4.00x3.25 meters. Its patches are made out of 20-mm flat plywood and are CNC milled. The structure has been exhibited at the IASS Barcelona 2019 Expo (7-11 October 2019), at the Maker Faire in Rome (18-20 October 2019) and at the prestigious 17th International Architecture Exhibition – La Biennale di Venezia 2021, within the Italian Pavilion (22 May-21 November 2021, Fig. 4). The method was also employed to design and build another FlexMaps structure, which was manufactured and exhibited at UTS Sydney in 2020 (Fig. 5).

Volumetric Design

Moving from surfaces to solid volumes, it is possible to search for efficiency by designing axial-only stressed structures. Tensegrity is a combination of the words “tensile” and “integrity”, invented by Buckminster Fuller, who first introduced this structural system. A tensegrity structure consists of a set of isolated compressed components, included in a net of tensioned cable segments (“islands of compression in a sea of tension” as defined by Buckminster Fuller himself).

The balancing of tension and compression generates stable elements. These structures are also appreciated in architecture and art contexts for their aesthetics, in particular for the weightless appearance of the floating struts. At the VCLab we investigated a method to enable the form-finding of these structures, notoriously a complex problem. Most existing design methods are based on the repetition of templated modules and are limited to simple shapes.

Establishing the arrangement of the components within a fixed volume is a complex



Fig 4. FlexMaps Pavilion at the 17th International Architecture Exhibition – La Biennale di Venezia 2021.



Fig 5. FlexMaps2 at UTS School of Architecture, Faculty of Design, Architecture and Building, Sydney 2020.

combinatorial problem. Research at ISTI aims at bridging the gap between artistic freedom when designing complex shapes

and the practical need to compute a tensegrity system that faithfully approximates these input shapes. An automatic method

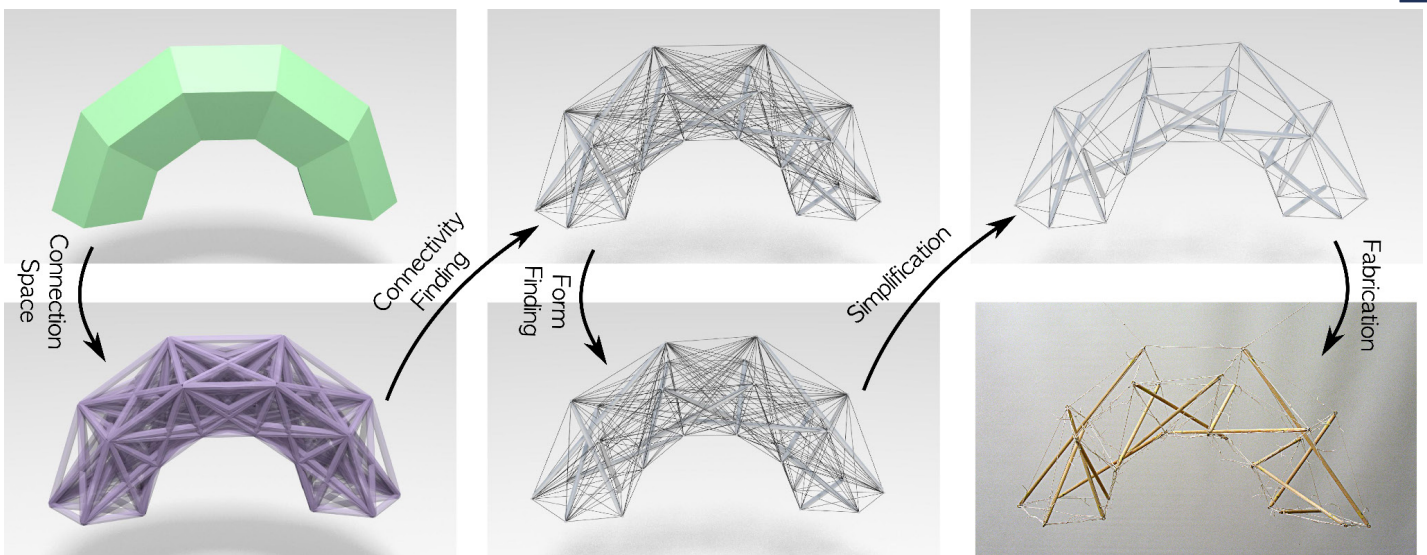

Fig 6. Automatic design pipeline for position-based Tensegrity structures.

was developed to achieve this (Fig. 6) and the system has been employed to build a large demonstrator, currently exhibited in the main square of the CNR Research Area in Pisa (Fig. 7).

The Future

The research results mentioned cover only a small set of the possibilities offered by AG and are not entirely representative of the full scale of the research in this field. The importance of AG research is evidenced by the fact that, nowadays, architectural firms rely heavily on software tools to complete the most challenging buildings projects. The tools employed are rarely developed ad-hoc and are often too generic and inadequate for specific applications. Most projects adopt a trial-and-error process which involves many subsequent iterations to obtain a result which, usually yields suboptimal performances. We believe that in the future computer-aided design tools will have to incorporate automatic state of the art methods such as the ones developed at ISTI. The Visual Computing Lab is currently investigating different lines of research aimed at developing automatic computational methods for the following case scenarios:

- automation of complex design tasks, very difficult or infeasible for humans, in the process of engineering a desired structure;
- offer novel solutions and alternative ex-



Fig 7. A full-scale manufactured tensegrity structure designed with the computational method developed at ISTI.

ploitation of construction materials;

- provide a characteristic aesthetics to an architectural shape without compromising its mechanical performance;
- exploit theoretical results to act on the design and slightly modify an input shape to improve its static performance or to render feasible particularly complex designs.

The Visual Computing Lab is deeply committed into AG Research. Exciting new applications are currently under way and will be showcased soon.

**Contacts: Francesco Laccone,
Davide Pellis, Luigi Malomo
and Paolo Cignoni, VC Lab**
francesco.laccone@isti.cnr.it
davide.pellis@isti.cnr.it
luigi.malomo@isti.cnr.it
paolo.cignoni@isti.cnr.it

SUN

Social and hUman ceNtered XR Funded by Horizon Europe

The Social and hUman ceNtered XR (SUN) project has been launched in December 2022. SUN has been approved for funding by the European Commission within the Horizon Europe program, HORIZON-CL4-2022-HUMAN-01-14 - eXtended Reality Technologies (RIA).

SUN aims at investigating and developing extended reality (XR) solutions that integrate the physical and virtual worlds convincingly from a human and social perspective.

The virtual world will be a means to augment the physical world with new opportunities for social and human interaction.

The project will address the following problems:

- Lack of strategies to develop scalable and cost-effective new XR applications;
- Lack of convincing solutions to mix the virtual and physical environments;



- Lack of plausible human interaction interfaces in XR;
- Barriers due to resource limitations of end-user devices;
- We will develop solutions to overcome current deficiencies, including:
 - Development of scalable solutions to obtain plausible and convincing virtual copies of physical objects and environments;
 - Development of solutions for a seamless and convincing interaction between the physical and the virtual world;
 - Development of wearable sensors and haptic interfaces for convincing and natural interaction with the virtual environment;
 - Development of artificial intelligence-based solutions to address current computing, memory, and network limitations of wearable devices;

The results will be demonstrated in three real-life scenarios:

1. XR for rehabilitation after accident or sickness.
2. XR in the industrial context to increase safety and improve social interaction among workers.
3. XR to remove interaction barriers for people with disabilities.

ISTI will coordinate the SUN project and will participate with the Artificial Intelligence for Media and Humanities (AIMH - <http://aimh.isti.cnr.it/>) and Visual Computing (VC - <http://vcg.isti.cnr.it/>) laboratories.

Contact: Giuseppe Amato, AIMH Lab
giuseppe.amato@isti.cnr.it



SoBigData RI PPP

SoBigData RI ESFRI Preparatory Phase Project Funded by Horizon Europe

The SoBigData RI Preparation Phase Project (PPP), coordinated at ISTI-CNR, is the first phase of the SoBigData Research Infrastructure set out in the ESFRI RoadMap 2021.



SoBigData RI is a distributed and multidisciplinary research infrastructure which exploits social mining, big data, and artificial intelligence to understand the complexity of our contemporary, globally interconnected society in an open and FAIR (Findable Accessible Interoperable Reusable) perspective.

In this new project (parallel to the initial project SoBigData++), the consortium will work on modeling and defining a legal entity (ERIC - European Research Infrastructure Consortium) in order to acquire legal status and develop strategies for RI governance. This also means acquiring financial support from the member states to build a business plan for long-term sustainability and also defining strategies both for services offered and for involvement by the research community and industry.

The SoBigData RI PPP aims to support the rising demand for cross-disciplinary research and innovation on multiple aspects

of social complexity from combined data-driven and model-driven perspectives, without forgetting the goal of democratizing the benefits of data science within an ethical framework that harmonizes individual rights and collective interest. The starting point to tackle these challenges is to observe how our society functions. The enormous volume of data originating from the digital evidence of human activities offers considerable opportunity to scrutinize individual and collective behaviors in unprecedented detail and on a global scale. This increasing wealth of data is a chance to understand social complexity via social mining, i.e., extracting knowledge from large volumes of social data.

In order to achieve this objective, the project intends to avoid duplication of efforts and exploit economies of scale by promoting common standards, encouraging the sharing of resources, and establishing joint research,

development, and programming capabilities among existing research centers in Europe as well as helping to train a new generation of data scientists.

The SoBigData RI PPP consortium comprises 33 partners from 17 countries (Bulgaria, Belgium, France, Greece, Spain, Austria, Italy, Germany, Estonia, Finland, the Netherlands, Poland, Sweden, and the UK). The partners will enlarge their collaboration networks locally to establish their presence as nodes of the future ERIC.

The SoBigData PPP began in October 2022 and will end in September 2025.

Contact: Roberto Trasarti, KDD Lab
roberto.trasarti@isti.cnr.it
<http://www.sobigdata.eu/>

CODECS

Maximizing the CO-benefits of agricultural digitalization through Conducive Digital ECoSystems Funded by Horizon Europe

CODECS will co-develop user-friendly approaches, methods, and tools to assess both the co-benefits and the costs of technologies in real agricultural contexts.

This assessment will be carried out in collaboration with farmers and Agricultural Knowledge and Innovation Systems (AKIS) actors. CODECS will improve the collective capacity to understand, assess and foresee the full range of benefits and costs of farm digitalization, and to build digital ecosystems that maximize the net benefits of digitalization. It will develop a vision of “sustainable digitalization” that will contribute to a multi-level transition linking social, economic, and ecological aspects by adopting an innovative system-based/actor-centered approach, and an action research methodol-

ogy based on the coordination of 21 Living Labs through interdisciplinary and transdisciplinary teams.

CODECS will study the role of ‘digital ecosystems’ in the uptake of digital technologies and in the distribution of their costs and benefits. Three indicators (farmers’ digital readiness, scaling readiness, digital ecosystem conduciveness) will be developed and tested to monitor the level of digitalization and foresee its potential costs and benefits. The full range of social, economic, and environmental costs and benefits of farm digitalization will be developed and compared, identifying synergies and trade-offs between different sources of costs and benefits. Digital technologies will be demonstrated and tested in 21 Living Labs both

in-situ and virtually. The CODECS platform will host search, demonstration, and assessment tools.

CODECS intends to strongly impact the AKIS domain; this will be achieved through a dedicated work package on policy analysis and tools. A set of policy briefs and webinars will be developed and an engagement strategy at the local, national, and European level, with a science-policy interface, an AKIS network, and a network of demo farms, will be established via the Living Labs.

Contacts: F. Manlio Bacco, WN Lab,
Alessio Ferrari, FMT Lab
manlio.bacco@isti.cnr.it
alessio.ferrari@isti.cnr.it

Tuscany X.0

Tuscany EU Digital Innovation Hub Funded by Digital Europe Programme

Tuscany X.0 (TX0) is a federation of all the main players in research and technology transfer in Tuscany. The hub is composed of 3 system integrators, 3 access points, and 13 providers. While the research and technology transfer area in the Tuscan region is rich in highly qualified institutions, the industrial sector is fragmented and composed of a large number of SMEs, too often the last sacrificial elements in long international supply chains.

TX0 aims at becoming a no-profit system integrator, coordinating technology transfer, and supporting the growth of the regional economy. The objective is to work with other European Digital Innovation Hubs (EDIHs) with the goal of achieving technological independence in Europe. Before asking for

industrial commitment and investment, Tuscany needs a demonstrably successful system integrator.

TX0 will focus on the adoption of advanced technologies through their customization to tangible industrial needs, requirements, and constraints. AI, CS and HPC will be integrated as a powerful toolbox that can enhance the level of industrial and public digital maturity in manufacturing, healthcare, tourism, etc.

The TX0 management system is driven by the goals of the EDIH Call, declined into specific project objectives, measured by key results, that are obtained through activities, monitored by specific KPIs with pre-defined targets to achieve (in terms of provided

services). The management system will be implemented in a customer relationship software on the basis of targets achieved. This evidence-based approach promotes the effectiveness and quality of activities and encourages the emergence of best practices.

TX0 partners are: the Polo Navacchio, Gate 4.0, Artes 4.0, Digital Innovation Hub Toscana, Eurosportello Confesercenti, Digital Ecosystem for Innovation, National Research Council, University of Firenze, University of Pisa, University of Siena, the Scuola Normale Superiore, Sant’Anna School of Advanced Studies, IMT School for Advanced Studies Lucca.

Contact: Fabrizio Falchi, AIMH Lab
fabrizio.falchi@isti.cnr.it

FAIRCORE4EOSC

FAIRCORE4EOSC: Core components supporting a FAIR EOSC Funded by Horizon Europe

The European Open Science Cloud (EOSC) is an ecosystem of research data and related services that will enable and enhance seamless access to and reliable reuse of FAIR research outputs such as data, publications, software and more. One of the priorities highlighted in the EOSC Strategic Research and Innovation Agenda (SRIA) is the establishment of the Web of FAIR data and a Minimum Viable EOSC by 2027, featuring the core components and operational functions of EOSC. The development of the EOSC-Core was initiated by Horizon 2020 projects which have delivered a rich palette of use cases, demonstrations, data, services and tools. However, there are challenges that still need to be addressed.

Bridging EOSC Core Gaps

FAIRCORE4EOSC will deliver nine new EOSC-Core components in support of a FAIR research life cycle, bridging the gaps identified in the EOSC SRIA. More specifically, these components will enable an EOSC PID infrastructure, an EOSC research software infra-

FAIRCORE4EOSC

Core Components Supporting a FAIR EOSC



structure, support for sharing and access to metadata schemas and crosswalks and offer advanced research-intent driven discovery services over all EOSC repositories.

Five user-centric case studies

The nine FAIRCORE4EOSC components will be crucial in sustaining the FAIR research life cycle. Five user-centric case studies will drive the development and testing of the new components in:

Climate change

- Social sciences and humanities
- Mathematics
- National research information systems
- Research data management communities.

The selected case studies share challenges that are common to other stakeholder groups; the co-design methodology will ensure that FAIRCORE4EOSC components are tailored to meet user needs. User stories and best practices identified by the case studies will be used to foster uptake of the new components beyond the project partners. FAIRCORE4EOSC will work in close collaboration with other actors in the EOSC ecosystem, including the EOSC Association itself, the H2020 project EOSC-Future, as well as the newly launched FAIR-IMPACT.

Contact: Claudio Atzori, InfraScience Lab-
claudio.atzori@isti.cnr.it
www.faircore4eosc.eu



Skills4EOSC

Skills for the European Open Science Commons: creating a training ecosystem for Open and FAIR Science - Funded by Horizon Europe

Skill4EOSC, an Italian-led project for open science training in Europe, was launched in Pisa in September 2022. The project is coordinated by GARR - the consortium responsible for the Italian National Research and Education Network - and is funded under the Horizon Europe framework program.

Skill4EOSC will set up a pan-European network of competence centers to speed up the training of European researchers and harmonize the training of new professional figures for scientific data management, ISTI will contribute by leveraging the experience and know-how acquired in this area.

Over the next three years, the project will work to provide Open Science Commons and create an EOSC-ready skilled European workforce, connecting existing centers of competence in open science and scientific data management. The aim is to develop methodologies, activities, and training resources to unify the current training landscape into a collaborative and reliable ecosystem and to provide dedicated community-specific support for open and data-intensive research.

The project consortium brings together 44 partners, representing the most experienced competence centers for open science and scientific data management in 18 European countries (Italy, the Netherlands, France, Finland, Denmark, Norway, Greece, Bulgaria, Serbia, Macedonia, Germany, Belgium, Austria, Poland, Sweden, Estonia, and Spain).

The project is structured around six key areas of activity:

1. Minimum Viable Skillsets (MVS)

Skill4EOSC will chart a comprehensive map of different career profiles and define an MVS for each one, i.e. a set of minimum requirements for competence and proficiency levels tailored to a specific Open Science professional profile.

2. Training-of-Trainers (ToT)

ToT enables cost-effectively scaling up trainer numbers. Working via a network embracing 18 European countries, Skill4EOSC will bring an extra dimension of rigour to this approach.

3. FAIR-by-design methodology for learning materials

Skill4EOSC will define a methodology to ensure the full compliance of training courses and materials to the FAIR (Findable, Accessible, Interoperable and Reusable) principles¹, making them reusable for humans and machines.

4. Harmonised curricula and learning paths

Skill4EOSC will harmonize Open Science curricula and learning paths targeting researchers at different career stages, data professionals and policymakers and offering discipline-, thematic- and research infrastructure-oriented training. This action will allow for the creation of curricula for specific professional profiles that are recognized across Europe.



5. Lifelong learning through professional networks:

Skill4EOSC will harness professional and thematic networks of peers as vehicles for lifelong learning and for building and sustaining the EOSC-ready digitally skilled workforce following the rapid evolution of Open Science domain and professional needs.

6. Skills4EOSC Competence Centre and support network

Skills4EOSC will put in place activities to align and sustain the key outputs of the project (i.e. curricula, quality assurance and certification frameworks for skills and materials, professional networks, user support networks and ToT programs) and user support platforms through the creation of a broad network across Competence Centers.

Contact: **Leonardo Candela**,
InfraScience Lab
leonardo.candela@isti.cnr.it
<https://www.skills4eosc.eu>

¹ Wilkinson, M. D. et al. The FAIR Guiding Principles for scientific data management and stewardship. *Sci. Data* 3:160018 doi: 10.1038/sdata.2016.18 (2016).

LODLNB

“L’ora di Lezione non Basta” (LODLNB)

Funded by ACRI (Associazione di Fondazioni e di Casse di Risparmio - Organisation of Foundations and Savings Banks)

The Project “L’Ora Di Lezione Non Basta” (the classroom is not enough) takes up the challenge that “educational poverty” or the lack of educational opportunities poses in Italy, in particular for individuals with specific disabilities. The intention is to strengthen the didactic communities that revolve around the school, capitalizing on the experience gained in approximately 500 schools that are part of the Italian National Network “Senza Zaino” (see <https://www.senzazaino.it/>).

Fifteen educational institutes from “Senza Zaino”, distributed over eight regions and fifteen national partners, are participating in the project. Each institute has expertise of value in the development of a didactic community.

The underlying assumption of the project is that the main point of reference for a community intending to tackle local “educational poverty” should be the school. The school can connect the different actors in the community responsible for cultural, social, educational, health, economic and administrative functions. In this way, the activities of the local community become opportunities for growth, innovation and transformation of the school.

The Signals and Images Laboratory of ISTI is a partner in the “L’Ora Di Lezione Non Basta” Project.

The main goal is to provide families and the entire local community with suggestions, ideas and strategies (accompanied by digital

technology) to promote the well-being of children with motorial, visual and, more generally, learning problems.

The idea is to build up a network of actors and relationships that, starting from the local context of each institution involved, can share models and strategies throughout the country.

**Contact: Giuseppe Fusco and
Davide Moroni, SI Lab**
giuseppe.fusco@isti.cnr.it
davide.moroni@isti.cnr.it

L'ORA
DI LEZIONE
NON BASTA

A path-aware scheduler for air-to-ground multipath multimedia delivery in real time

A. Machumilane, A. Gotta, P. Cassarà, M. Bacco

IEEE Communications Magazine, vol. 60. IEEE, 2022.

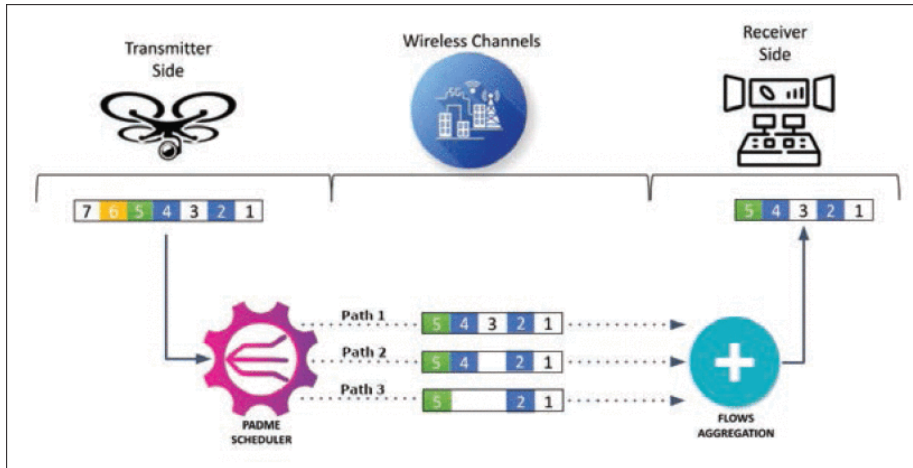

A multimedia stream is sent from a UAV to a GCS via multiple wireless paths. The PADME scheduler selects the subset of links and the redundancy rate to be used.

the challenging scenario of real-time video streaming from an Unmanned Aerial Vehicle (UAV) via multiple wireless channels. We propose a lightweight scheduler capable of dynamically selecting the paths to be used and of determining the necessary redundancy rate to protect the multimedia flow. Our scheduler, implemented as a module of the GStreamer framework, can be used in real or simulated settings. The results we present show that the proposed scheduler can be used to target a very low loss rate by dynamically adapt to varying channel conditions in terms of losses and experienced delay.

DOI: 10.1109/MCOM.001.2100904

The use of multipath techniques in transmission has emerged in the last years thanks to their potential in increasing throughput.

They can also be used as a means to counteract errors or losses in transmission, thus increasing reliability. In this work, we focus on

E2E-PLR of PADME, TEE, and WRR for comparable PLRs (circles and diamonds), and of heterogeneous PLR (squares).

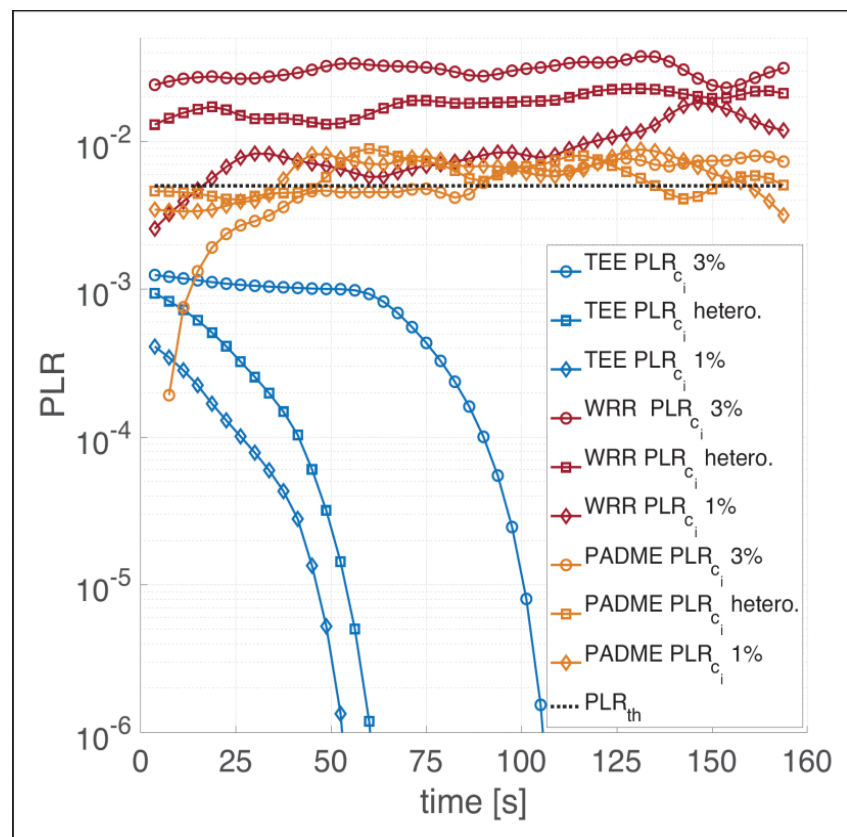

Evaluation of angle of arrival in indoor environments with bluetooth 5.1 direction finding

M. Girolami, P. Barsocchi, F. Furfari, D. La Rosa, F. Mavilia

18th International Conference on Wireless and Mobile Computing, Networking and Communications. IEEE, 2022.

The Bluetooth 5.1. Direction Finding (DF) specification opens to the possibility of estimating the angle between an emitting and a receiving device. Such angle is generally measured estimating the Angle of Arrival

(AoA) or the Angle of Departure (AoD). In particular, knowledge about AoA between a set of anchor nodes and a moving target could be used to localize the target, with greater accuracy with respect to traditional

approaches based on the Received Signal Strength of the received messages. In this work, we rigorously evaluate the performance of a commercial kit implementing the DF specification, with the purpose of understanding how the AoA measure varies with respect to the angles' ground truth. We describe two real-world experimental scenarios and we compute the errors between the estimated and actual angles. We also discuss three key aspects for the purpose of adopting BT 5.1 in indoor localization applications.

DOI: 10.1109/WiMob55322.2022.9941619

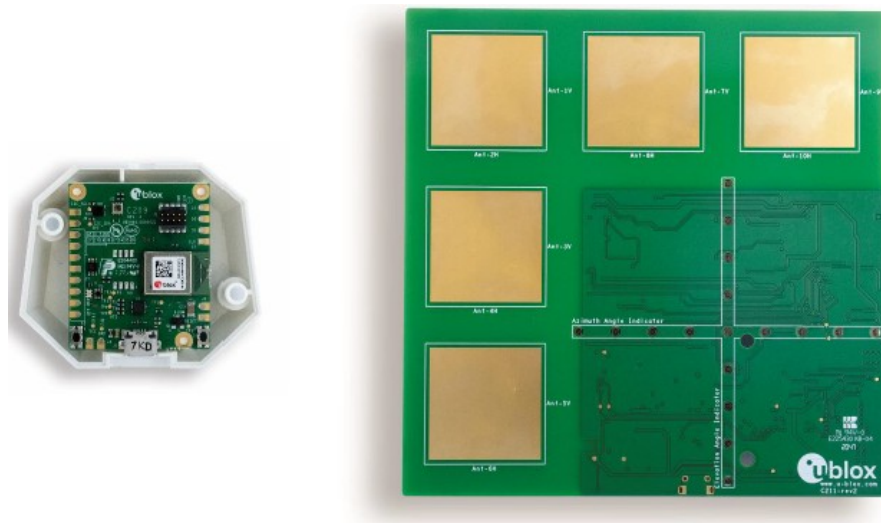

The xplr-aoa explorer kit: the tag and the anchor..

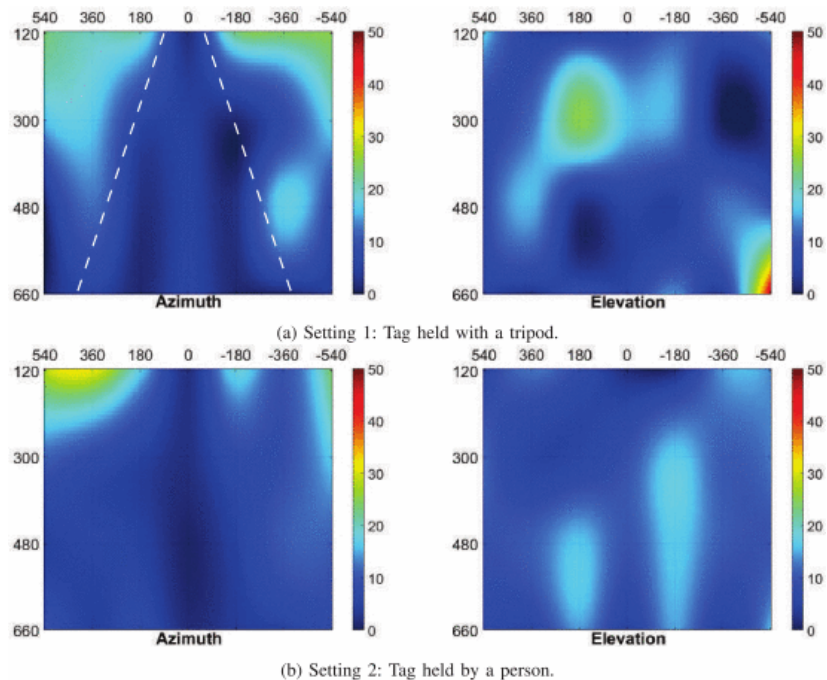

Scenario 1: variation of the mean absolute error (mae) with anchor a ($z=266$ cm, $\alpha=32^\circ$), settings 1 and 2.

Systematic evaluation and usability analysis of formal methods tools for railway signaling system design

A. Ferrari, F. Mazzanti, D. Basile, M.H. ter Beek

IEEE Transactions on Software Engineering, vol. 48. IEEE, 2022.

Formal methods and supporting tools have a long record of success in the development of safety-critical systems. However, no single tool has emerged as the dominant solution for system design. Each tool differs from the others in terms of the modeling language used, its verification capabilities and other complementary features, and each development context has peculiar needs that require different tools. This is particularly problematic for the railway industry, in which formal methods are highly recommended by the norms, but no actual guidance is provided for the selection of tools. To guide companies in the selection of the most appropriate formal methods tools to adopt in their contexts, a clear assessment of the features of the currently available tools is required. To address this goal, this paper considers a set of 13 formal methods tools that have been used for the early design of railway systems, and it presents a systematic evaluation of such tools and a preliminary usability analysis of a subset of 7 tools, involving railway practitioners. The results are discussed considering the most desired aspects by

Category	Name	SPIN	Simulink	nuXmv	ProB	Abelard B	UPPAAL	FDRA	CPN Tools	CADP	mCRL2	SAL	TLA+	UMC
Development Functionalities	Specification / Modeling	TEXT	GRAPH	TEXT	TEXT	TEXT	GRAPH	TEXT	GRAPH	TEXT	TEXT	TEXT	TEXT	TEXT
	Code Generation	NO	YES	NO	NO	YES	PARTIAL	PARTIAL	NO	PARTIAL	NO	NO	NO	PARTIAL
	Documentation / Report Generation	PARTIAL	YES	NO	PARTIAL	PARTIAL	PARTIAL	PARTIAL	NO	PARTIAL	NO	NO	NO	NO
Verification Functionalities	Requirements Traceability	NO	YES	NO	NO	NO	NO	NO	NO	NO	NO	NO	NO	NO
	Project Management	NO	YES	NO	NO	YES	NO	NO	NO	NO	NO	NO	NO	NO
	Simulation	TEXT	GRAPH	TEXT	MIX	NO	GRAPH	TEXT	GRAPH	TEXT	TEXT	TEXT	TEXT	TEXT
Language Expressiveness	Formal Verification	MCL	MC-O	MCL-MC-S	MCL-MC-B	TP	MCL-LF	RF	MC-B	MC-B-RF	MC-B-RF	MC-LTP	MC-LTP	MC-B
	Large-scale Verification Technique	FLY-POR-PAR	BMC	BMC-SYM	SCT	SCT	SMC-SYM	COM-POR	BMC	COM-PAR	COM	PAR-SCT	SYM-SCT	FLY
	Model-based Testing	NO	YES	NO	YES	NO	YES	NO	NO	YES	NO	YES	NO	NO
Tool Flexibility	Non-determinism	INT	EXT	INT.EXT	INT.EXT	INT.EXT	INT.EXT	INT	INT	INT.EXT	INT.EXT	INT.EXT	INT	INT
	Concurrency	ASYNCH	NO	SYNCH	NO	NO	SYNCH	ASYNCH	ASYNCH	ASYNCH	ASYNCH	ASYNCH	ASYNCH	ASYNCH
	Timing Aspects	NO	YES	NO	NO	NO	YES	YES	YES	NO	YES	YES	NO	NO
Maturity	Stochastic or Probabilistic Aspects	NO	NO	NO	NO	NO	NO	NO	NO	NO	NO	NO	NO	NO
	Modularity of the Language	HIGH	HIGH	MEDIUM	LOW	MEDIUM	HIGH	HIGH	HIGH	HIGH	HIGH	MEDIUM	MEDIUM	HIGH
	Supported Data Structures	BASIC	COMPLEX	COMPLEX	COMPLEX	COMPLEX	COMPLEX	COMPLEX	COMPLEX	COMPLEX	COMPLEX	COMPLEX	COMPLEX	COMPLEX
Usability	Fluent Support	NO	YES	YES	NO	NO	YES	NO	NO	NO	NO	NO	NO	NO
	Team Support	LIKELY	YES	LIKELY	MODERATE	MODERATE	MODERATE	MODERATE	MODERATE	MODERATE	MODERATE	MODERATE	MODERATE	MODERATE
	Standard Input Format	OPEN	PARTIAL	OPEN	OPEN	OPEN	OPEN	OPEN	OPEN	OPEN	OPEN	OPEN	OPEN	OPEN
Company Constraints	Import / Export vs. Other Tools	MEDIUM	LOW	MEDIUM	HIGH	MEDIUM	LOW	MEDIUM	MEDIUM	HIGH	HIGH	MEDIUM	LOW	MEDIUM
	Modularity of the Tool	LOW	HIGH	LOW	HIGH	MEDIUM	HIGH	LOW	LOW	HIGH	MEDIUM	LOW	LOW	MEDIUM
	Team Support	NO	NO	NO	NO	YES	NO	NO	NO	NO	NO	NO	NO	NO
Railway-specific Criteria	Stage of Development	HIGH	HIGH	HIGH	HIGH	HIGH	HIGH	MEDIUM	MEDIUM	MEDIUM	MEDIUM	LOW	MEDIUM	LOW
	Availability of Customer Support	MATURE	MATURE	MATURE	MATURE	MATURE	MATURE	MATURE	MATURE	MATURE	MATURE	MATURE	MATURE	PROTOTYPE
	Graphical User Interface	PARTIAL	YES	PARTIAL	YES	YES	YES	PARTIAL	PARTIAL	PARTIAL	PARTIAL	PARTIAL	PARTIAL	PARTIAL
Railway-specific Criteria	Mathematical Background	LIMITED	YES	NO	PARTIAL	PARTIAL	YES	LIMITED	PARTIAL	LIMITED	PARTIAL	NO	LIMITED	PARTIAL
	Quality of Documentation	MEDIUM	BASIC	MEDIUM	MEDIUM	ADVANCED	MEDIUM	ADVANCED	MEDIUM	ADVANCED	ADVANCED	ADVANCED	ADVANCED	MEDIUM
	Integration in the CENELEC Process	GOOD	EXCELLENT	GOOD	GOOD	EXCELLENT	GOOD	EXCELLENT	GOOD	GOOD	GOOD	GOOD	GOOD	LIMITED
Railway-specific Criteria	Cost	FREE	PAY	MIX	FREE	FREE	MIX	MIX	FREE	MIX	FREE	MIX	FREE	FREE
	Supported Platforms	ALL	ALL	ALL	ALL	ALL	ALL	ALL	Windows	ALL	ALL	ALL	ALL	ALL
	Complexity of License Management	EASY	ADEQUATE	EASY	EASY	EASY	MODERATE	MODERATE	EASY	MODERATE	EASY	EASY	EASY	EASY
Railway-specific Criteria	Easy to Install	YES	YES	YES	YES	YES	YES	YES	YES	PARTIAL	YES	YES	YES	YES
	CENELEC Certification	NO	PARTIAL	NO	NO	NO	NO	NO	NO	NO	NO	NO	NO	NO
	Integration in the CENELEC Process	MEDIUM	YES	MEDIUM	YES	YES	MEDIUM	MEDIUM	MEDIUM	MEDIUM	LOW	LOW	LOW	MEDIUM

Evaluation table.

industry and earlier related studies. While the focus is on the railway signaling domain, the overall methodology can be applied to similar contexts. Our study thus contributes with a systematic evaluation of formal methods tools and it shows that despite the poor graphical interfaces, usability and maturity of the tools are not major problems, as claimed by contributions from the literature. Instead, support for process integration is

the most relevant obstacle for the adoption of most of the tools. Our contribution can be useful to R&D engineers from railway signaling companies and infrastructure managers, but also to tool developers and academic researchers alike.

DOI: 10.1109/TSE.2021.3124677

Static detection of equivalent mutants in real-time model-based mutation testing: an empirical evaluation

D. Basile, M.H. ter Beek, S. Lazreg, M. Cordy, A. Legay

Empirical Software Engineering, vol. 27. Springer, 2022.

Model-based mutation testing has the potential to effectively drive test generation to reveal faults in software systems. However, it faces a typical efficiency issue since it could produce many mutants that are equivalent to the original system model, making it impossible to generate test cases from them. We consider this problem when model-based mutation testing is applied to real-time system product lines, represented

as timed automata. We define novel, time-specific mutation operators and formulate the equivalent mutant problem in the frame of timed refinement relations. Further, we study in which cases a mutation yields an equivalent mutant. Our theoretical results provide guidance to system engineers, allowing them to eliminate mutations from which no test case can be produced. Our empirical evaluation, based on a proof-of-

concept implementation and a set of benchmarks from the literature, confirms the validity of our theory and demonstrates that in general our approach can avoid the generation of a significant amount of the equivalent mutants.

DOI: 10.1007/s10664-022-10149-y

Geometric model checking of continuous space

N. Bezhanishvili, V. Ciancia, D. Gabelaia, G. Grilletti, D. Latella, M. Massink
Logical Methods in Computer Science, vol. 18. LMCS, 2022.

Topological Spatial Model Checking is a recent paradigm where model checking is applied to the topological interpretation of Modal Logic. The Spatial Logic of Closure Spaces, SLCS, extends Modal Logic with reachability connectives, used for expressing spatial properties such as “being connected to” or “being surrounded by”. SLCS is the core of the VoxLogicA framework for analysing graphs and digital images (instances of quasi discrete closure spaces). Following a recently developed geometric semantics of Modal Logic, in this article we interpret SLCS in continuous space by resorting to models based on polyhedra. Such representations of space are increasingly relevant in many

application domains, due to recent developments of 3D scanning and visualisation techniques that exploit mesh processing. We introduce PolyLogicA, a geometric spatial model checker for SLCS on polyhedra, and demonstrate feasibility of our approach on two 3D polyhedral models of realistic size. As an example, in Fig. 1 a 3D maze is shown that consists of “rooms” connected by “corridors”. The rooms come in four colours: white, black, green and one room in red. The green rooms are all situated at the outer boundary of the maze and represent the surroundings of the maze that can be reached via an exit. The white, black and red rooms, and related corridors, are situated inside the cube and

form the maze itself. Fig. 2 shows the result of evaluating an SLCS formula characterizing the white rooms and their connecting corridors from which a green room can be reached without passing by black rooms, including the green room that is reached. White rooms and their connecting corridors from which both a red and a green room can be reached not passing by black rooms are shown in Fig. 3. Finally, we introduce a definition of bisimilarity characterising logical equivalence.

DOI: 10.46298/lmcs-18(4:7)2022

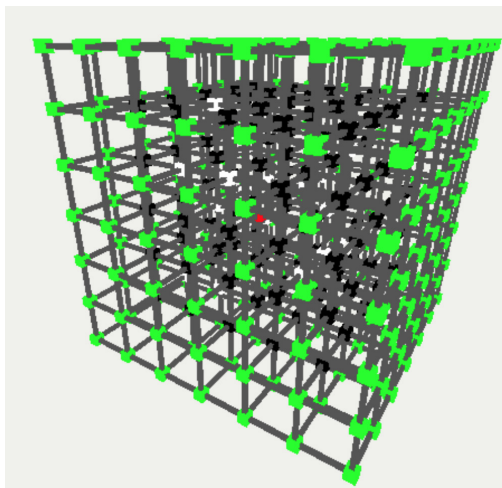

Fig. 1

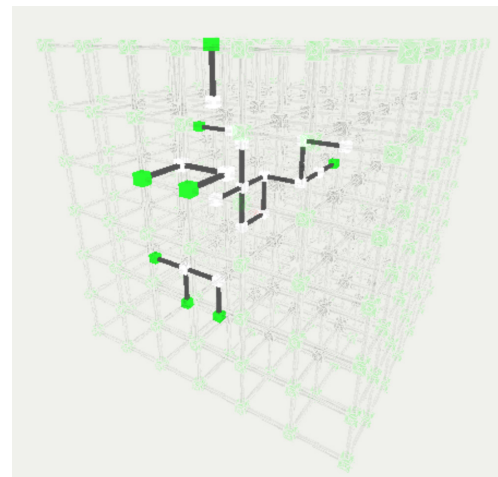

Fig. 2

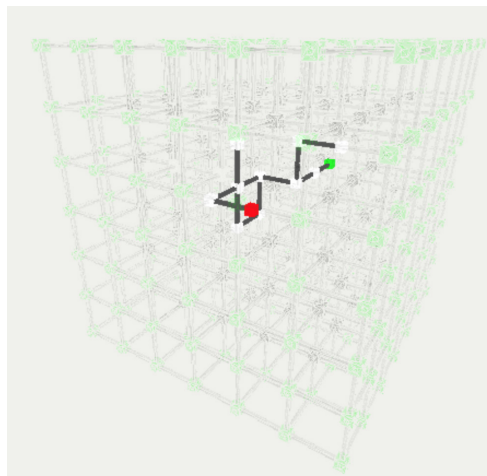

Fig. 3

How do requirements evolve during elicitation? An empirical study combining interviews and app store analysis

A. Ferrari, P. Spoletini, S. Debnath

Requirements Engineering, vol. 27. Springer, 2022.

Requirements are elicited from the customer and other stakeholders through an iterative process of interviews, prototyping, and other interactive sessions. Then, requirements can be further extended, based on the analysis of the features of competing products available on the market. Understanding how this process takes place can help to identify the contribution of the different elicitation phases, thereby allowing requirements analysts to better distribute their resources. In this work, we empirically study in which way requirements get transformed from initial ideas into documented needs, and then evolve based on the inspiration coming from similar products. To this end, we select 30

subjects that act as requirements analysts, and we perform interview-based elicitation sessions with a fictional customer. After the sessions, the analysts produce a first set of requirements for the system. Then, they are required to search for similar products in the app stores and extend the requirements, inspired by the identified apps. The requirements documented at each step are evaluated, to assess to which extent and in which way the initial idea evolved throughout the process (see figure to have an overview of the whole process). Our results show that only between 30% and 38% of the requirements produced after the interviews include content that can be fully traced to the initial

customer's ideas. The rest of the content is dedicated to new requirements, and up to 21% of it belongs to completely novel topics. Furthermore, up to 42% of the requirements inspired by the app stores cover additional features compared to the ones identified after the interviews. The results empirically show that requirements are not elicited in a strict sense, but actually co-created through interviews, with analysts playing a crucial role in the process. In addition, we show evidence that app store-inspired elicitation can be particularly beneficial to complete the requirements.

DOI: 10.1007/s00766-022-00383-7

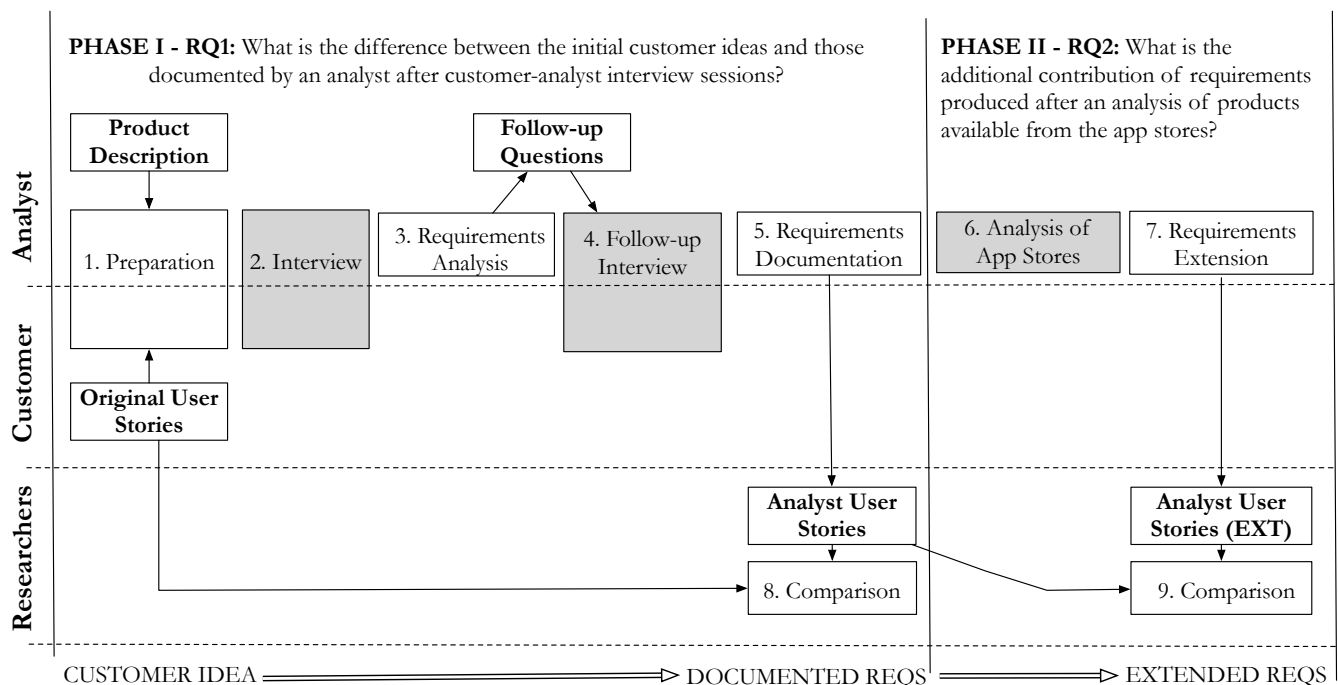

Experimental process adopted in the study.

Solution bundles of Markov performability models through adaptive cross approximation

G. Masetti, L. Robol, S. Chiaradonna, F. Di Giandomenico

52ndIEEE/IFIP International Conference on Dependable Systems and Networks IEEE, 2022.

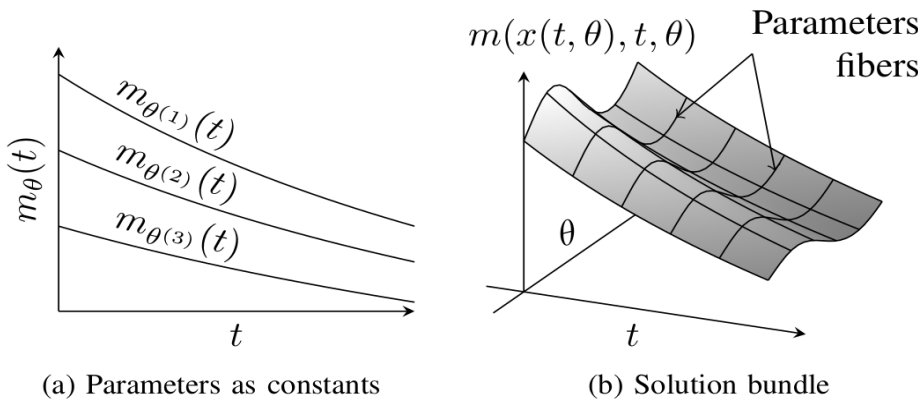

Different treatment of parameters: (a) as constants, (b) as variables. The proposed application of ACA exploits efficient computational strategies to evaluate measures along time and parameters' fibers.

parametric model where parameters are treated as independent variables instead of constants, is presented in this paper. The expected advantage is that analyses based on an approximated solution bundle are more efficient than those that solve the model for all combinations of parameters' values separately.

More specifically, here the idea is to properly adapt low rank tensor approximation techniques, and in particular Adaptive Cross Approximation (ACA), to the evaluation of performability attributes. Therefore, the main contribution of this paper is the development of an efficient and accurate method to evaluate performability measures along fibers, exploiting the separable approximants feature of ACA.

Application on exemplary case studies confirms the advantages of the new solution technique with respect to solving the model for all time and parameters' combinations.

Stochastic model-based analysis is widely adopted to study dependability, performance and performability attributes of complex systems. To account for uncertainty of parameter values, or to study the sensitivity of the analysed metrics to variability of the parameters setting, it is often required to solve the model for different time and parameters assignments. For large sys-

tems, this kind of analysis is extremely time consuming and have limited applicability at growing the number of model parameters.

Borrowing terminology from physics, solving a model where parameters are made variables produces a solution bundle. Then, a technique to approximate solution bundles for Markov models, i.e., solutions of a

DOI: 10.1109/DSN53405.2022.00046

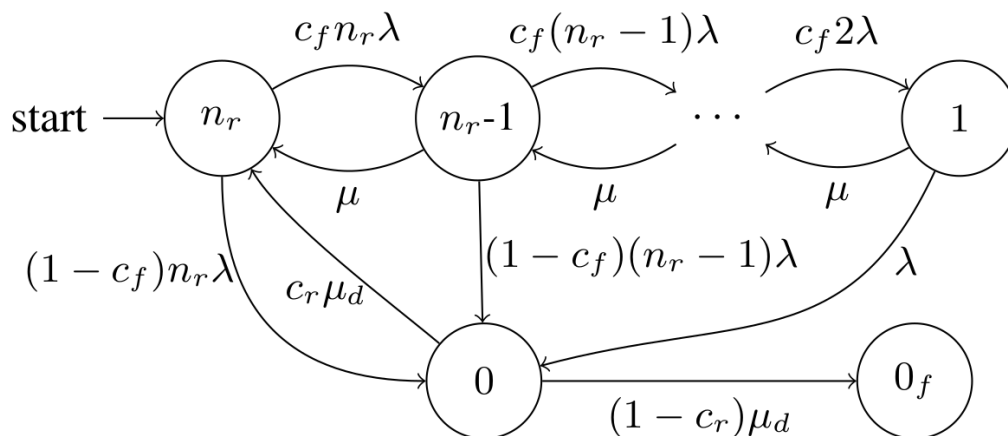

Running example: CTMC of Case study 1, representing a degradable system with failure coverage and repair. Each state $i \geq 0$ represents the number i of currently operational components; 0_f represents the system failure. Full description is in Section V-A

Linking different scientific digital libraries in Digital Humanities: the IMAGO case study

V. Bartalesi, N. Pratelli, E. Lenzi

International Journal on Digital Libraries, vol. 23. Springer, 2022.

In the last years, several scientific digital libraries (DLs) in Digital Humanities (DH) field have been developed following the Open Science principles. These DLs aim to share the research outcomes as FAIR data and create linked information spaces. In several cases, Semantic Web technologies and Linked Data have been used to reach these aims. This paper presents how the current scientific DLs in the DH field can be used for creating linked information spaces and navigational services, using Semantic Web technologies to formally represent, search

and browse knowledge. To support the argument, we present our experience in developing a scientific DL supporting scholars in creating, evolving and consulting a knowledge base related to Medieval and Renaissance geographical works within the three years (2020-2023) Italian National research project IMAGO--Index Medii Aevi Geographiae Operum.

In the presented case study, a linked information space was created to allow users to discover and navigate knowledge across

multiple repositories, thanks to the extensive use of ontologies. In particular, the linked information spaces created within the IMAGO project use five different datasets, i.e. Wikidata, MIRABILE digital archive, Nuovo Soggettario thesaurus, Mapping Manuscript Migration knowledge base and the Pleiades gazetteer. The linking among different datasets considerably enriches the knowledge collected in the IMAGO KB.

DOI: 10.1007/s00799-022-00331-4

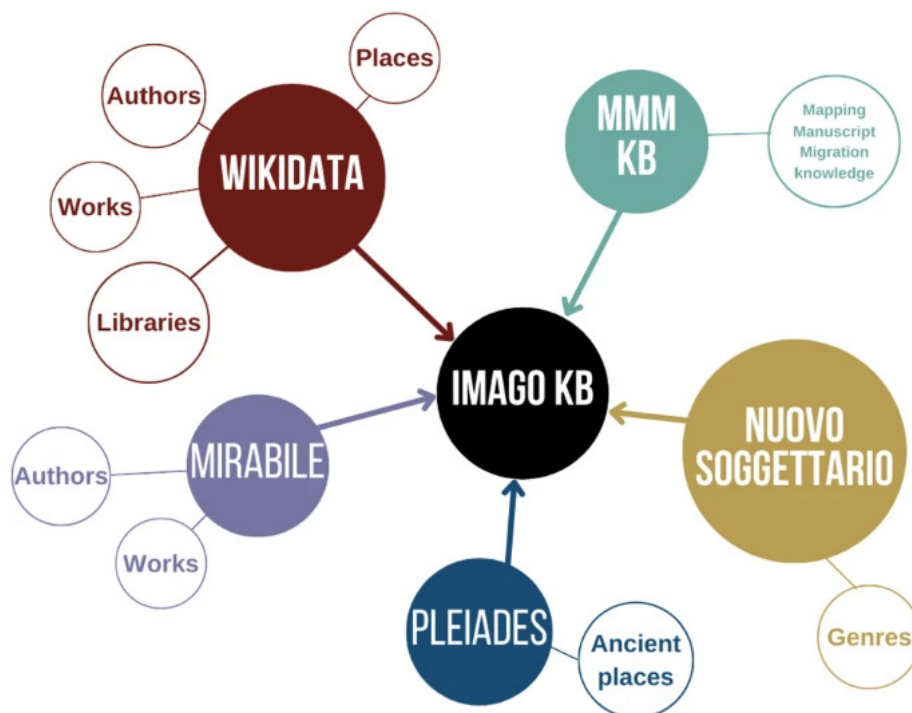

Graphical representation of the IMAGO KB and the linked datasets, along with the extracted entity types.

The transparency of automatic web accessibility evaluation tools: design criteria, state of the art, and user perception

M. Manca, V. Palumbo, F. Paternò, C. Santoro

ACM Transactions on Accessible Computing, in press. ACM, 2022.

Several Web accessibility evaluation tools have been put forward to reduce the burden of identifying accessibility barriers for users, especially those with disabilities. One common issue in using accessibility evaluation tools in practice is that the results provided by different tools are sometimes unclear, and often diverging. Such limitations may confuse the users who may not understand the reasons behind them, and thus hamper the possible adoption of such tools. Hence, there is a need for tools that shed light on their actual functioning, and the success

criteria and techniques supported. For this purpose, we must identify what criteria should be adopted in order for such tools to be transparent and to help users better interpret their results. In this paper, we discuss such issues, provide design criteria for obtaining user-centred and transparent accessibility evaluation tools, and analyse how they have been addressed by a representative set of open, license-free, accessibility tools. We also report on the results of a survey with 138 users of such tools, aimed at capturing the perceived usefulness of

previously identified transparency requirements. Finally, we performed a user study with 18 users working in the Web design or accessibility fields with the goal of receiving more feedback about the transparency of a selected subset of accessibility tools.

DOI: 10.1145/3556979

Tool Name	C1 What is supported	C2 How issues are categorized	C3: How reported info are provided	C4: Info on how to solve issues	C5: Info on limitations
aCe by accessiBe	✗	⚠	✓ Metric+annot.code+ preview	✗	✗
Accessi.org	✗	✗	✗ Only annotated code	✓ link to W3C	✗
Accessibility Scanning By UserWay	✗	✓	⚠ annotated code+preview	✗	✗
EqualWeb	✗	✗	⚠ Metric + annot.code	✓ link to W3C	✗
Accessibility Checker by EXPERTE	⚠	✓	✓ Metric + annot. code + preview	✓ link to WebDev.com	✓
Free Web Accessibility check by AlumniOnline	⚠	✗	✗ Only annotated code	✓ link to W3C	⚠
IBM Equal Access Accessibility Checker	✓	⚠	⚠ Metric + annotated code	✓ Provide recommendation	⚠
MAUVE++	✓	⚠	✓ Metric+annot.code+ preview	link to W3C	✓
QualWeb	✓	⚠	⚠ annot.code+ preview	link to W3C	✓
TAW	✗	⚠	✗ Only annotated code	✗	✗
WAVE	✓	⚠	⚠ Annotated code+preview	✓ link to W3C	✗

Analysis of Tools' Transparency Features.

End-user development in industrial contexts: the paper mill case study

M. Manca, F. Paternò, C. Santoro

Behaviour & Information Technology, vol. 41. Taylor&Francis, 2022.



A paper machine with jumbo rolls in the foreground (from VOITH).

This work aims to explore the potentialities of an end-user personalisation platform in industrial settings. In such a context, stake-

holders with different roles and competencies collaborate to manage and control an environment where legacy machines coex-

ist and interact with newer ones. Our goal is to provide a rule-based tool that allows end-users to build personalised solutions to respond quickly to the dynamic needs of factories. We report on a case study in the paper factory domain, in which the industrial aspects identified with expert stakeholders through interviews have been simulated and addressed through an extension of a personalisation platform. A first user test of the resulting environment has been carried out with a representative set of users, and has provided useful and encouraging feedback in terms of the potentialities of the proposed approach in industrial contexts.

DOI: 10.1080/0144929X.2022.2089597

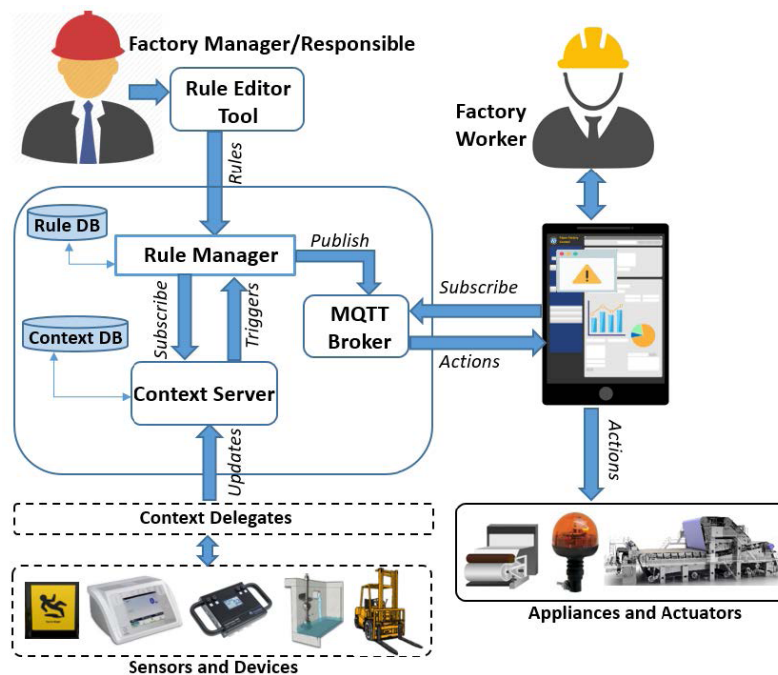

The Platform Architecture.

Filling gaps in trawl surveys at sea through spatiotemporal and environmental modelling

G. Coro, P. Bove, E.N. Armelloni, F. Masnadi, M. Scanu, G. Scarcella
Frontiers in Marine Science, vol. 9. Frontiers, 2022.

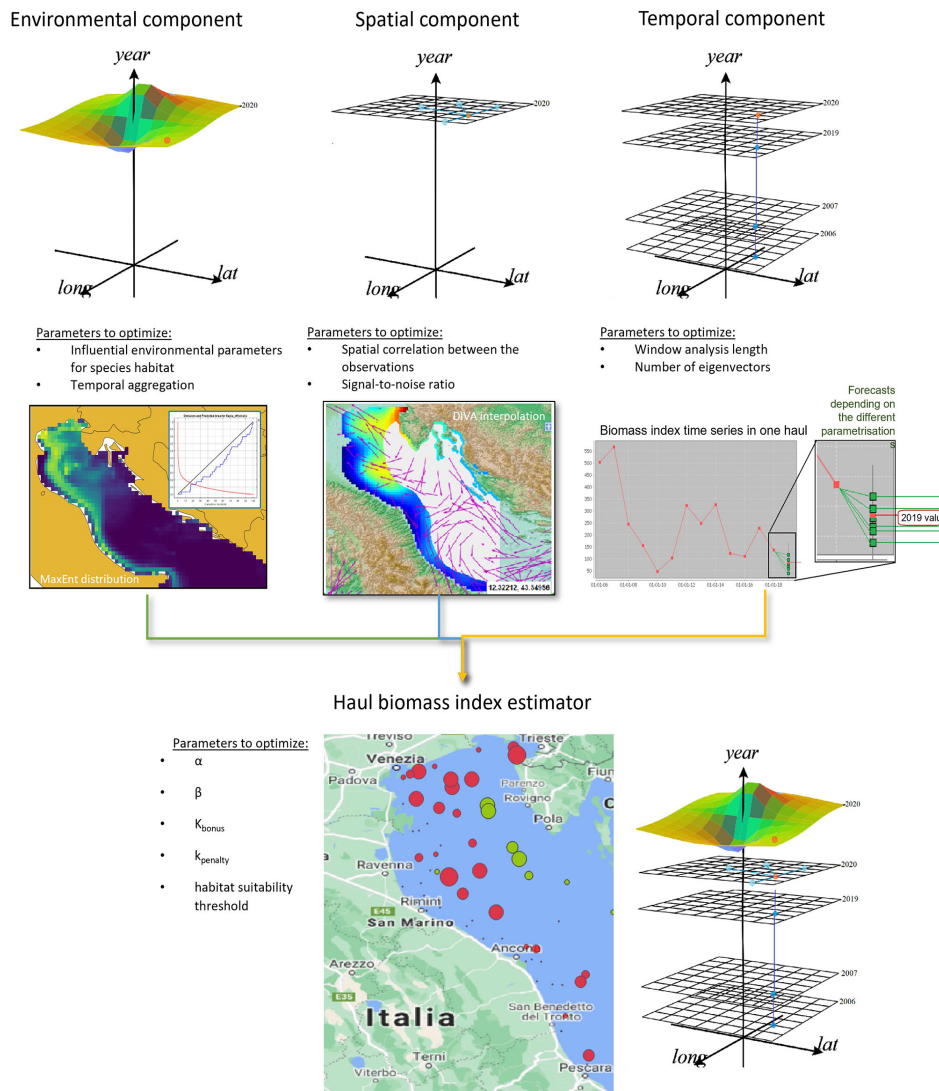

Overview of our overall biomass-index estimation model and its three.

International scientific fishery survey programmes systematically collect samples of target stocks' biomass and abundance and use them as the basis to estimate stock status in the framework of stock assessment models. The research surveys can also inform decision makers about Essential Fish Habitat conservation and help define harvest control rules based on direct observa-

tion of biomass at the sea. However, missed survey locations over the survey years are common in long-term programme data. Currently, modelling approaches to filling gaps in spatiotemporal survey data range from quickly applicable solutions to complex modelling. Most models require setting prior statistical assumptions on spatial distributions, assuming short-term temporal

dependency between the data, and scarcely considering the environmental aspects that might have influenced stock presence in the missed locations. This paper proposes a statistical and machine learning based model to fill spatiotemporal gaps in survey data and produce robust estimates for stock assessment experts, decision makers, and regional fisheries management organizations. We apply our model to the SoleMon survey data in North-Central Adriatic Sea (Mediterranean Sea) for 4 stocks: *Sepia officinalis*, *Solea solea*, *Squilla mantis*, and *Pecten jacobaeus*. We reconstruct the biomass-index (i.e., biomass over the swept area) of 10 locations missed in 2020 (out of the 67 planned) because of several factors, including COVID-19 pandemic related restrictions. We evaluate model performance on 2019 data with respect to an alternative index that assumes biomass proportion consistency over time. Our model's novelty is that it combines three complementary components. A spatial component estimates stock biomass-index in the missed locations in one year, given the surveyed location's biomass-index distribution in the same year. A temporal component forecasts, for each missed survey location, biomass-index given the data history of that haul. An environmental component estimates a biomass-index weighting factor based on the environmental suitability of the haul area to species presence. Combining these components allows understanding the interplay between environmental-change drivers, stock presence, and fisheries. Our model formulation is general enough to be applied to other survey data with lower spatial homogeneity and more temporal gaps than the SoleMon dataset.

DOI: 10.3389/fmars.2022.919339

Habitat distribution change of commercial species in the Adriatic Sea during the COVID-19 pandemic

G. Coro, P. Bove, A. Ellenbroek

Ecological Informatics, vol. 69. Elsevier, 2022.

The COVID-19 pandemic has led to reduced anthropogenic pressure on ecosystems in several world areas, but resulting ecosystem responses in these areas have not been investigated. This paper presents an approach to make quick assessments of potential habitat changes in 2020 of eight marine species of commercial importance in the Adriatic Sea. Measurements from floating probes are interpolated through an advection-equation based model. The resulting distributions are then combined with species observations through an ecological niche model to estimate habitat distributions in the past years (2015-2018) at 0.1° spatial resolution. Habitat patterns over 2019 and 2020 are then extracted and explained in terms of specific environmental parameter changes. These changes are finally assessed for their potential dependency on climate change patterns and anthropogenic pressure change due to the pandemic. Our results demonstrate that the combined effect of climate change and the pandemic could have heterogeneous effects on habitat distributions: three species (*Squilla mantis*, *Engraulis encrasicolus*, and *Solea solea*) did not show significant niche distribution change; habitat suitability positively changed for *Sepia officinalis*, but negatively for *Parapenaeus longirostris*, due to increased temperature and decreasing dissolved oxygen (in the Adriatic) generally correlated with climate change; the combination of these trends with an average decrease in chlorophyll, probably due to the pandemic, extended the habitat distributions of *Merluccius merluccius* and *Mullus barbatus* but reduced *Sardina pilchardus* distribution. Although our results are based on approximated data and reliable at a mac-

roscopic level, we present a very early insight of modifications that will possibly be observed years after the end of the pandemic when complete data will be available. Our approach is entirely based on Findable, Accessible, Interoperable, and Reusable (FAIR)

data and is general enough to be used for other species and areas.

DOI: 10.1016/j.ecoinf.2022.101675

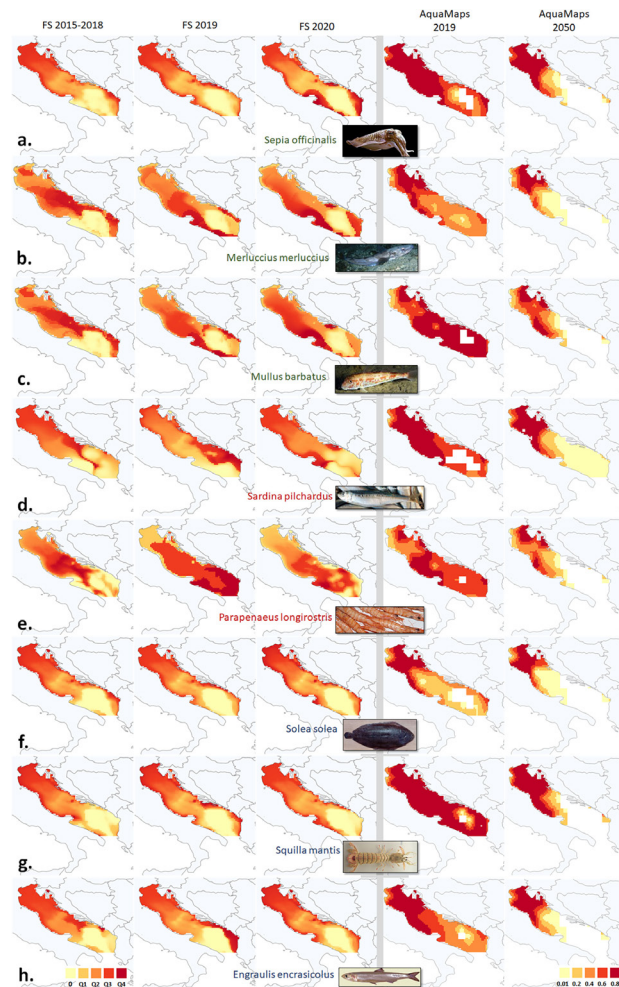

Ecological niches estimated by our floating sensor based (FS) models for 2015–2018, 2019, and 2020, and AquaMaps 2019 and 2050 over the eight analysed species. Coloured species names indicate habitat gain (green), change (red), or stability (blue) in 2020 with respect to 2015–2018. (For interpretation of the references to colour in this figure legend, the reader is referred to the web version of this article).

The potential effects of COVID-19 lockdown and the following restrictions on the status of eight target stocks in the Adriatic Sea

G. Scarcella, S. Angelini, E.N. Armelloni, I. Costantini, A. De Felice, S. Guicciardi, I. Leonori, F. Masnadi, M. Scanu, Coro G.

Frontiers in Marine Science, in press. Frontiers, 2022.

The COVID-19 pandemic had major impacts on the seafood supply chain, also reducing fishing activity. It is worth asking if the fish stocks in the Mediterranean Sea, which in most cases have been in overfishing conditions for many years, may have benefitted from the reduction in the fishing pressure. The present work is the first attempt to make a quantitative evaluation of the fishing effort reduction due to the COVID-19 pandemic and, consequently, its impact on Mediterranean fish stocks, focusing on Adriatic Sea subareas. Eight commercially exploited target stocks (common sole, common cuttlefish, spottail mantis shrimp, European hake, red mullet, anchovy, sardine, and deepwater pink shrimp) were evaluated with a surplus production model, separately fitting the data for each stock until 2019 and until 2020. Results for the 2019 and 2020 models in terms of biomass and fishing mortality were statistically compared with a bootstrap resampling technique to assess their statistical difference. Most of the stocks showed a small but significant improvement in terms of both biomass at sea and reduction in fishing mortality, except cuttlefish and pink shrimp, which showed a reduction in biomass at sea and an increase in fishing mortality (only for common cuttlefish). After reviewing the potential co-occurrence of environmental and management-related factors, we concluded that only in the case of the common sole can an effective biomass improvement related to the pandemic restrictions be detected,

because it is the target of the only fishing fleet whose activity remained far lower than expectations for the entire 2020.

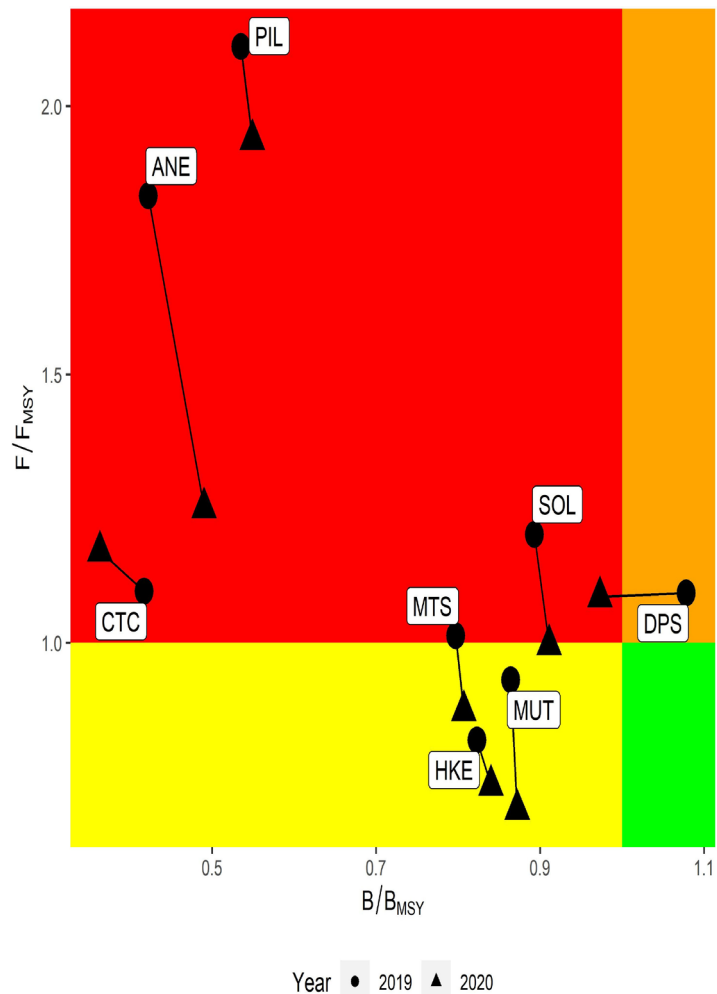

Kobe plot showing the outputs of CMSY/BSM of eight Adriatic Sea target stocks in 2019 (triangle) and 2020 (circle). Lines link the outputs for the same species in different years.

DOI: 10.3389/fmars.2022.920974

Tweet sentiment quantification: an experimental re-evaluation

A. Moreo, F. Sebastiani

PLOS ONE, vol. 17. Public Library of Science, 2022.

Sentiment quantification is the task of training, by means of supervised learning, estimators of the relative frequency (also called “prevalence”) of sentiment-related classes (such as Positive, Neutral, Negative) in a sample of unlabelled texts. This task is especially important when these texts are tweets, since the final goal of most sentiment classification efforts carried out on Twitter data is actually quantification (and not the classification of individual tweets). It is well-known that solving quantification by means of “classify and count” (i.e., by classifying all unlabelled items by means of a standard classifier and counting the items that have been assigned to a given class) is less than optimal in terms of accuracy, and that more accurate quantification methods exist. Gao and Sebastiani 2016 carried out a systematic comparison of quantification methods on the task of tweet sentiment quantification. In hindsight, we observe that the experimentation carried out in that work was weak, and that the reliability of the conclusions that were drawn from the results is thus questionable. We here re-evaluate those quantification methods (plus a few more modern ones) on exactly the same datasets, this time following a now consolidated and robust experimental protocol (which also involves simulating the presence, in the test data, of class prevalence values very different from those of the training set). This experimental protocol (even without counting the newly added methods) involves a

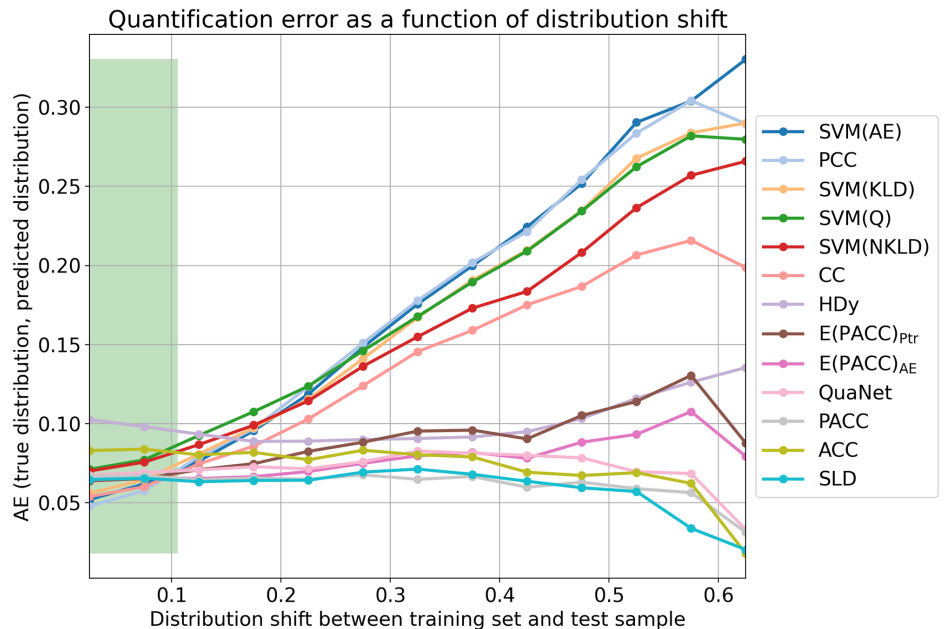

Performance of the various quantification methods, represented by the coloured lines and measured in terms of AE (lower is better), as a function of the distribution shift between training set and test sample; the results are averages across all samples in the same bin, i.e., characterised by approximately the same amount of shift, independently of the dataset they were sampled from.

The two vertical dotted lines indicate the range of distribution shift values exhibited by the experiments of [GS2016] (i.e., in those experiments, the AE values of distribution shift range between 0.020 and 0.1055). The green histogram in the background shows instead how the samples we have tested upon are distributed across the different bins.

number of experiments 5,775 times larger than that of the original study. Due to the above-mentioned presence, in the test data, of samples characterised by class prevalence values very different from those of the training set, the results of our experiments are dramatically different from those obtained

by Gao and Sebastiani, and provide a different, much more solid understanding of the relative strengths and weaknesses of different sentiment quantification methods.

DOI: 10.1371/journal.pone.0263449

Where do migrants and natives belong in a community: a Twitter case study and privacy risk analysis

J. Kim, · F. Pratesi, · G. Rossetti, · A. Sirbu, · F. Giannotti

Social Network Analysis and Mining, vol. 13. Springer, 2022.

Today, many users are actively using Twitter to express their opinions and to share information. Thanks to the availability of the data, researchers have studied behaviours and social networks of these users. International migration studies have also benefited from this social media platform to improve migration statistics. Although diverse types of social networks have been studied so far on Twitter, social networks of migrants and natives have not been studied before. This paper aims to fill this gap by studying characteristics and behaviours of migrants and natives on Twitter. To do so, we perform a general assessment of features including

profiles and tweets, and an extensive network analysis on the network. We find that migrants have more followers than friends. They have also tweeted more despite that both of the groups have similar account ages.

More interestingly, the assortativity scores showed that users tend to connect based on nationality more than country of residence, and this is more the case for migrants than natives. Furthermore, both natives and migrants tend to connect mostly with natives. The homophilic behaviours of users are also well reflected in the communities that we detected. Our additional privacy risk analy-

sis showed that Twitter data can be safely used without exposing sensitive information of the users, and minimise risk of re-identification, while respecting GDPR. In particular, through this study, we provided different scenarios where the risk of re-identification can vary from very high to very low. This would provide other researchers with a guideline on how to deal with data privacy issues when working with Twitter data, helping to find the suitable trade-off for a specific analysis.

DOI: 10.1007/s13278-022-01017-0

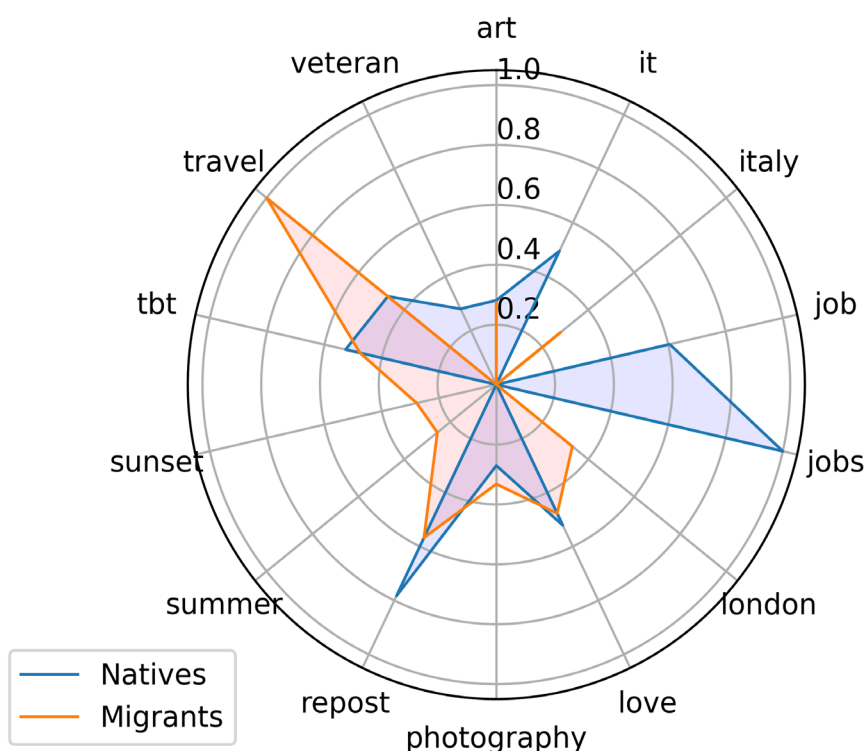

Top 14 hashtags used by migrants and natives. Right: Degree distribution of the network.

Generating mobility networks with generative adversarial networks

G. Mauro, M. Luca, A. Longa, B. Lepri, L. Pappalardo
EPJ Data Science, vol. 11. Springer 2022.

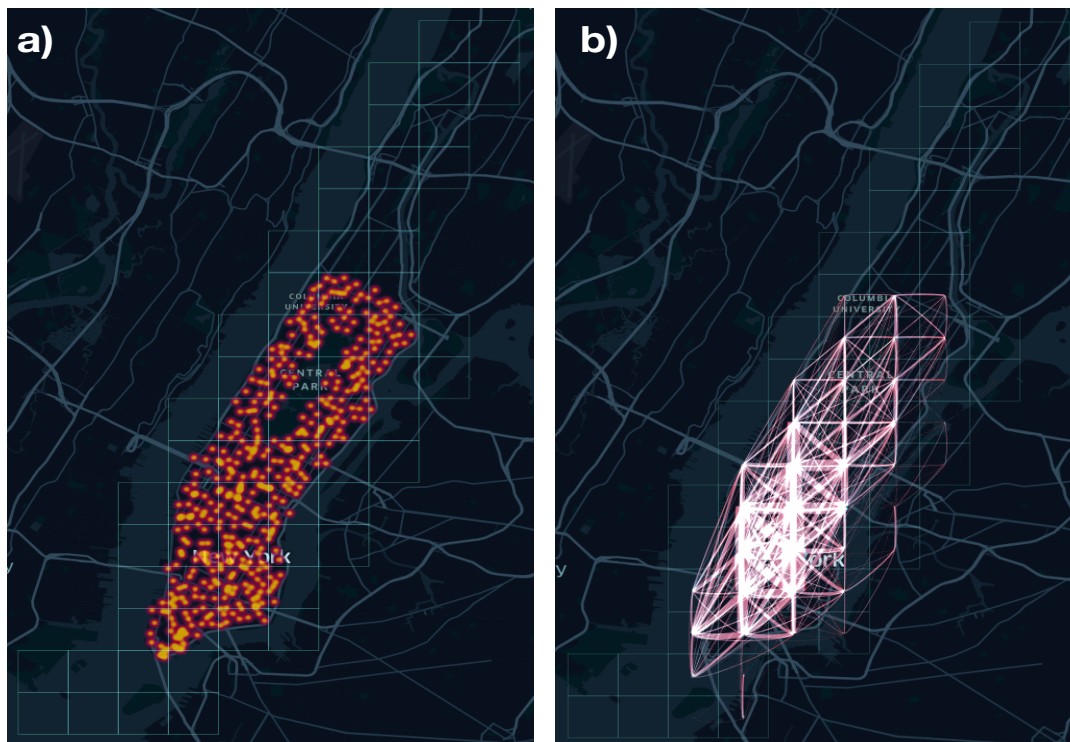

Examples of a real mobility network. (a) Position of bike stations in Manhattan. (b) A daily mobility network in Manhattan, where the size of each edge is proportional to the flow they represent.

Mobility network generation is the problem of generating a city's entire mobility network, a weighted directed graph in which nodes are geographic locations and weighted edges represent people's movements between those locations, thus describing the entire mobility set flows within a city.

As a solution to this problem we propose MoGAN, a model based on Generative Adversarial Networks (GANs) to generate realistic mobility networks. GANs are AI architectures able to capture the probability distribution of a training set and to replicate it for creating a new sample with the same probability distribution (therefore realistic)

but not belonging to the training set. Traditionally, GANs have been used for generating images, represented as triple-channel matrices. MoGAN can generate mobility networks, representing them as adjacency matrices.

We conduct extensive experiments on public datasets of bike and taxi rides in two cities (New York City and Chicago, USA) to show that MoGAN outperforms both the classical flow generation models (the Gravity and the Radiation models) and a randomized baseline model, regarding the realism of the generated networks. As to prove this performance improvement, we propose a tailored

approach for evaluating the generating ability of our model.

Considering the difficulties in obtaining mobility data for privacy issues, our model can be a useful tool for data augmentation. Furthermore, you can use MoGAN for simulating urban traffic scenarios and performing what-if analysis.

The code for reproducing and replicating our architecture, as well as our analysis, is public and can be found at <https://github.com/jonpappalord/GAN-flow>.

DOI: 10.1140/epjds/s13688-022-00372-4

The Istella22 dataset: bridging traditional and neural learning to rank evaluation

D. Dato, S. Macavanay, F.M. Nardini, R. Perego, N. Tonellotto

The 45th International ACM SIGIR Conference on Research and Development in Information Retrieval . ACM, 2022.

Neural ranking approaches that use pre-trained language models are effective at various ranking tasks, such as question answering and ad-hoc document ranking. However, their effectiveness compared to feature-based Learning-to-Rank (LtR) methods has not yet been well-established. A major reason for this is because present LtR benchmarks that contain query-document feature vectors do not contain the raw query and document text needed for neural models. On the other hand, the benchmarks often used for evaluating neural models, e.g., MS MARCO, TREC Robust, etc., provide the text but do not provide query-document feature vectors. In this paper, we present Istella22, a new dataset that enables such comparisons by providing both query/document text and strong query-document feature

vectors used by an industrial search engine. The dataset consists of a comprehensive corpus of 8.4M web documents, a collection of query-document pairs including 220 hand-crafted features, relevance judgments on a 5-graded scale, and a set of textual queries used for testing purposes. Istella22 enables a fair comparison of traditional learning-to-rank and transfer ranking techniques on exactly the same data. LtR models exploit the feature-based representations of training samples while transformers-based neural rankers can be evaluated on the corresponding textual content of queries and documents. Through preliminary experiments on Istella22, we find that neural re-ranking approaches lag behind LtR models in terms of absolute performance. However, LtR models identify the scores from neural

models as strong signals. Istella22 enables the IR community to study neural and traditional LtR on the same data.

The Istella22 dataset is made available to researchers at this URL <http://quickrank.isti.cnr.it/istella22-dataset>, according to the conditions detailed in the included license agreement. The dataset is also integrated into the `ir_datasets` library, making it easily accessible in a variety of neural ranking toolkits (e.g. PyTerrier, OpenNIR, and Capreolus) or accessing the data in an ad hoc manner. In other words, aside from being accessible through the released data files, the dataset is accessible through Python code, as shown below.

DOI: 10.1145/3477495.3531740

```
import ir_datasets
dataset = ir_datasets.load('istella22/test')
for doc in dataset.docs:
    print(doc)
# IstellaDoc(doc_id='07489924', title="...", text="...", ...)
for query in dataset.queries:
    print(query)
# GenericQuery(query_id='263', text='calcio mercato')
for qrel in dataset.qrels:
    print(qrel)
# GenericQrel(query_id='263', doc_id='83436604' relevance=3)
```

Example of use of the Istella22 dataset as part of the `ir_datasets` library.

Caching historical embeddings in conversational search

O. Frieder, I. Mele, C.I. Muntean, F.M. Nardini, R. Perego, N. Tonello
ACM Transactions on the Web, in press. ACM, 2022.



2D visualization of conversational queries (•) and corresponding relevant documents (x) for 5 CAS-T 2019 topics.

the embeddings of documents retrieved for a topic introduced in the conversation, as they are likely relevant to successive queries. Our document embedding cache implements an efficient metric index, answering nearest-neighbor similarity queries by estimating the approximate result sets returned. We demonstrate the efficiency achieved using our cache via reproducible experiments based on TREC CAS-T datasets, achieving a hit rate of up to 75% without degrading answer quality. Our achieved high cache hit rates significantly improve the responsiveness of conversational systems while likewise reducing the number of queries managed on the search back-end.

DOI: 10.1145/3578519

Rapid response, namely low latency, is fundamental in search applications; it is particularly so in interactive search sessions, such as those encountered in conversational settings. An observation with a potential to reduce latency asserts that conversational queries exhibit a temporal locality in the lists of documents retrieved. Motivated by this observation, we propose and evaluate a client-side document embedding cache, improving the responsiveness of conversational search systems. By leveraging state-of-the-art dense retrieval models to abstract document and query semantics, we cache

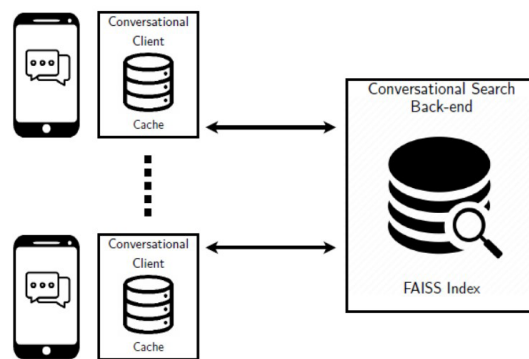

Architecture of a conversational search system with client-side caching.

Improving plant disease classification by adaptive minimal ensembling

A. Bruno, D. Moroni, R. Dainelli, L. Rocchi, S. Morelli, E. Ferrari, P. Toscano, M. Martinelli
 Frontiers in Artificial Intelligence, in press. Frontiers, 2022.

A novel method for improving plant disease classification, a challenging and time-consuming process, is proposed. First, using as baseline EfficientNet, a recent and advanced family of architectures having an excellent accuracy/complexity trade-off, we have introduced, devised, and applied refined techniques based on transfer learning, regularization, stratification, weighted metrics, and advanced optimizers in order to achieve improved performance. Then, we go further by introducing adaptive minimal ensembling, which is a unique input to the

knowledge base of the proposed solution. This represents a leap forward since it allows improving the accuracy with limited complexity using only two EfficientNet-b0 weak models, performing ensembling on feature vectors by a trainable layer instead of classic aggregation on outputs. To the best of our knowledge, such an approach to ensembling has never been used before in literature. Our method was tested on PlantVillage, a public reference dataset used for benchmarking models' performances for crop disease diagnostic, considering both its

original and augmented versions. We noticeably improved the state of the art by achieving 100% accuracy in both the original and augmented datasets. Results were obtained using PyTorch to train, test, and validate the models; reproducibility is granted by providing exhaustive details, including hyperparameters used in the experimentation. A Web interface is also made publicly available to test the proposed methods.

DOI: 10.3389/frai.2022.868926



Background



Background

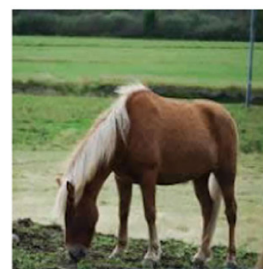

Background



Blueberry healthy



Raspberry healthy



Tomato healthy



Grape black rot



Corn cercospora



Peach bacterial spot

Some PlantVillage image examples. From top to bottom: 3 examples of background, 3 examples of healthy leaves, and 3 examples of diseases.

WordMelodies: supporting the acquisition of literacy skills by children with visual impairment through a mobile app

D. Ahmetovic, C. Bernareggi, B. Leporini, S. Mascetti

ACM Transactions on Accessible Computing, in press. ACM, 2022.

WordMelodies is a mobile app that aims to support inclusive teaching of literacy skills for primary school students. Thus it was designed to be accessible both visually and through screen reader, and it includes over 80 different types of exercises for practicing literacy skills, each with adjustable difficulty levels, in Italian and in English. WordMelodies is freely available for iOS and Android devices. However, it has not been previously

evaluated with children having visual impairments. Thus, in this paper, we evaluate the app usability, its perceived ease of use, appreciation and children's autonomy while using it, as well as the characteristics of the end users. To achieve this, we conducted a user study with 11 primary school students with visual impairments, and we analyzed app usage logs collected from 408 users in over one year from the app publication. We

show that app usability is high, and most exercises can be completed autonomously. The exercises are also perceived to be easy to perform, and they are appreciated by the participants. Finally, we provide insights on how to address the identified app limitations and propose future research directions.

DOI: 10.1145/3565029



(a) Drag the correct element(s)

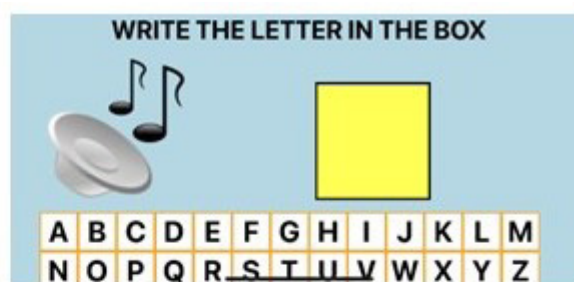

(b) Write with software keyboard

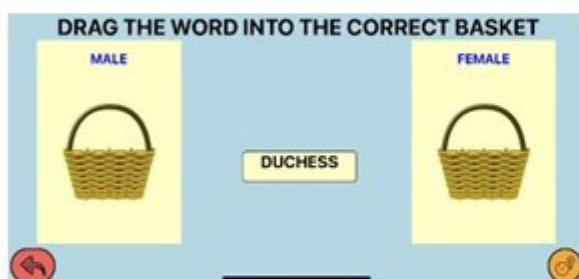

(c) Drag an item to the correct basket



(d) Select the correct answer



(e) Select multiple answers in table

Examples of exercises in WordMelodies from the five different exercise families.

Ambient Assisted Living: scoping review of artificial intelligence models, domains, technology and concerns

M. Jovanovic, G. Mitrov, E. Zdravevski, P. Lameski, S. Colantonio, M. Kampel, H. Tellioglu, F. Florez-Revuelta
JMIR. Journal of medical internet researchh, vol. 24. JMIR Publications, 2022.

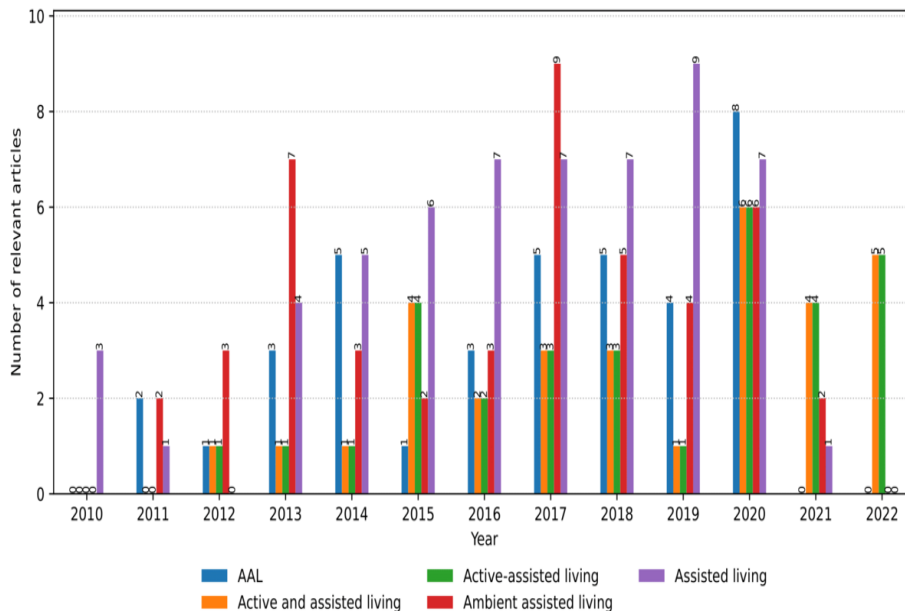

The number of relevant articles concerning ambient assisted living (AAL) with artificial intelligence classes and models per year from January 2010 to July 2022.

Background: Ambient Assisted Living (AAL) is a common name for various Artificial Intelligence (AI)-infused applications and platforms that support their users in need in multiple activities, from health to daily living. These systems use different approaches to learn about their users and make automated decisions, known as AI models, for personalizing their services and increasing outcomes. Given the numerous systems developed and deployed for people with different needs, health conditions, and dispositions towards the technology, it is critical to obtain clear and comprehensive insights concerning AI models employed, along with their domains, technology, and concerns, to identify prom-

ising directions for future work. Objective: This study provides a scoping review of the literature on AI models in AAL. In particular, we analyze: 1) specific AI models employed in AAL systems, 2) the target domains of the models, 3) the technology using the models, and 4) the major concerns from the end-user perspective. Our goal is to consolidate research on the topic and inform end-users, healthcare professionals and providers, researchers, and practitioners in developing, deploying, and evaluating future intelligent AAL systems. Methods: The study was conducted as a scoping review to identify, analyze and extract the relevant literature. It used a natural language processing (NLP)

toolkit to retrieve the article corpus for an efficient and comprehensive automated literature search. The relevant articles were then extracted from the corpus and analyzed manually. The review included five digital libraries: the Institute of Electrical and Electronics Engineers (IEEE), PubMed, Springer, Elsevier, and the Multidisciplinary Digital Publishing Institute (MDPI). Results: The annual distribution of relevant articles shows a growing trend for all categories from January 2010 to November 2021. The AI models started with unsupervised approaches as the leader, followed by deep learning (dominant from 2020), instance-based learning, and supervised techniques. Activity recognition and assistance were the most common target domains of the models. Ambient sensing, wearable, and mobile technologies mainly implemented the models. Older adults were primary beneficiaries, followed by patients and frail persons of various ages. Availability was a top beneficiary concern, and to less extent, reliability, safety, privacy, and security. Conclusions: The study presents the analytical evidence of AI models in AAL and their domains, technologies, beneficiaries, and concerns. Future research on intelligent AAL should: involve healthcare professionals and caregivers as designers and users, comply with health-related regulation, improve transparency and privacy, integrate with healthcare technological infrastructure, explain their decisions to the users, and establish evaluation metrics and design guidelines.

DOI: 10.2196/36553

SkinMixer: blending 3D animated models

S. Nuvoli, N. Pietroni, P. Cignoni, R. Scateni, M. Tarini
ACM Transaction on Graphics, vol. 41. ACM, 2022.

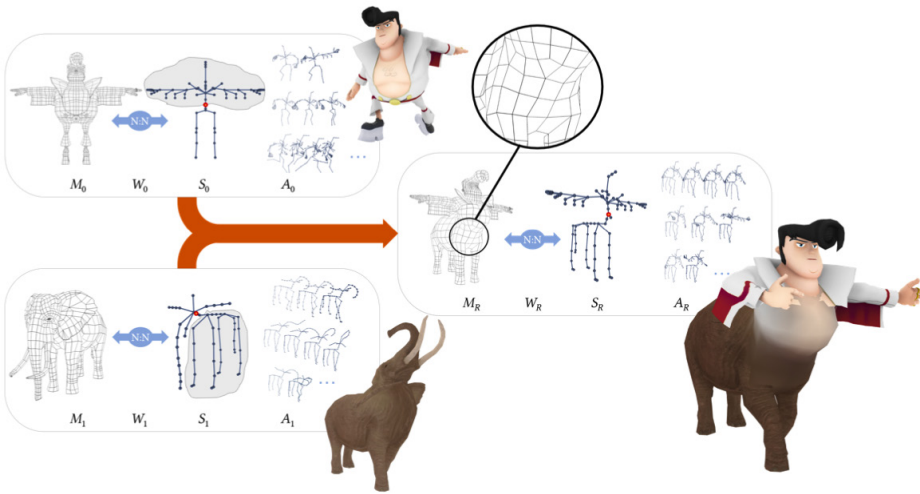

Our technique in action to mix-and-match animated skinned models. Two production-ready videogame models, comprising of a semi-regular quaddominant mesh $M_{0,1}$, a set of skinning weights $W_{0,1}$, a skeleton $S_{0,1}$, and a set of keyframe animations $A_{0,1}$, are automatically blended into a fully equipped model comprised of a semi-regular unified meshing M_R a skeleton S_R skinning weights W_R , and a new set of compatible animations A_R . A user intuitively specifies this process by simply selecting the portions of the skeleton to be merged (the subtrees in the gray areas rooted at the red dot).

Applications such as 3D Videogames or Virtual Reality require using a variety of 3D assets to recreate vibrant, realistic, reactive 3D virtual worlds. Producing these 3D assets is one of the main challenges for the developers, absorbing a considerable effort by highly specialized digital artists. One particularly work-intensive as- set class is 3D animated, rigged, skinned, models, used for digital characters.

We propose a novel technique to compose new 3D animated models, such as videogame characters, by mixing and matching pieces from existing ones. Our method works on production-ready rigged, skinned, and animated 3D models to allowing to assemble chimeras, such as a centaur obtained by joining a human torso with an elephant

body, or a mermaid obtained by assembling a woman torso with a fishtail. We exploit mix-and-match operations on the skeletons to trigger the automatic creation of a new mesh, linked to the new skeleton by a set of skinning weights and complete with a set of animations. The resulting model preserves the quality of the input meshings (which can be quad-dominant and semi-regular), skinning weights (inducing believable deformation), and animations, featuring coherent movements of the new skeleton. Our method enables content creators to reuse valuable, carefully designed assets by assembling new ready-to-use characters while preserving most of the hand-crafted subtleties of models authored by digital artists. This approach allows for drastically cutting the time needed to obtain the final result.

DOI: 10.1145/3550454.3555503



Models obtained by mixing different inputs in different ways. For each model, we show the inputs in rest pose and the result in one animated pose.

Vorogrid: a static-aware variable-density Voronoi mesh to design the tube structure tessellation of tall buildings

F. Laccone, D. Gaudio, L. Malomo, P. Cignoni, M. Froli

Computer-Aided Civil and Infrastructure Engineering, in press. Wiley, 2022.

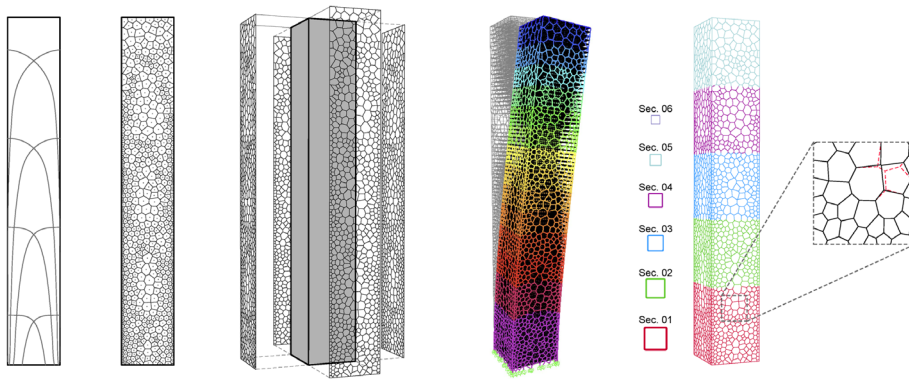

Vorogrid pipeline for generating variable-density Voronoi tube structures: (a) structural scheme, (b) seeds population and Voronoi mesh, (c) building of a 3D model, (d) structural analysis, and (e) optimization and cross-section refinement.

For skyscrapers, large building heights can be reached only through efficient structural systems able of balancing horizontal forces introduced by wind and earthquake. In the latest years, tube structures made of diamond patterns named 'diagrids' become widespread because of their easy design and efficiency. However, skyscrapers can strong-

ly characterize the urban environment so a growing interest is recently observed in searching for alternative geometries to replace the diagrid pattern and confer the building a more organic appearance. Vorogrid is a design method for tube structures of super-tall buildings (300-600 m), founded on the use of Voronoi meshes, whose edges

are converted into a grid of structural beams. The geometry of the Voronoi cells is steered to known structural schemes for the design of a cantilever tube. The objective is to mimic a macroscopic structural behavior through a topology and size modification of the cells. So the resulting Voronoi mesh presents an increased density along lines and areas of the schemes, namely where creating resisting paths with higher stiffness. The mesh is successively improved with a geometric and structural optimization for removing stress concentration, mitigating the effects of grid randomness and making the structure manufacturable. We obtained a new class of tall buildings structures with an organic-looking aesthetics and mechanically-sound tube structure, which makes them a valuable alternative to competitors (diagrid, hexagrid, random Voronoi).

DOI: 10.1111/mice.12912

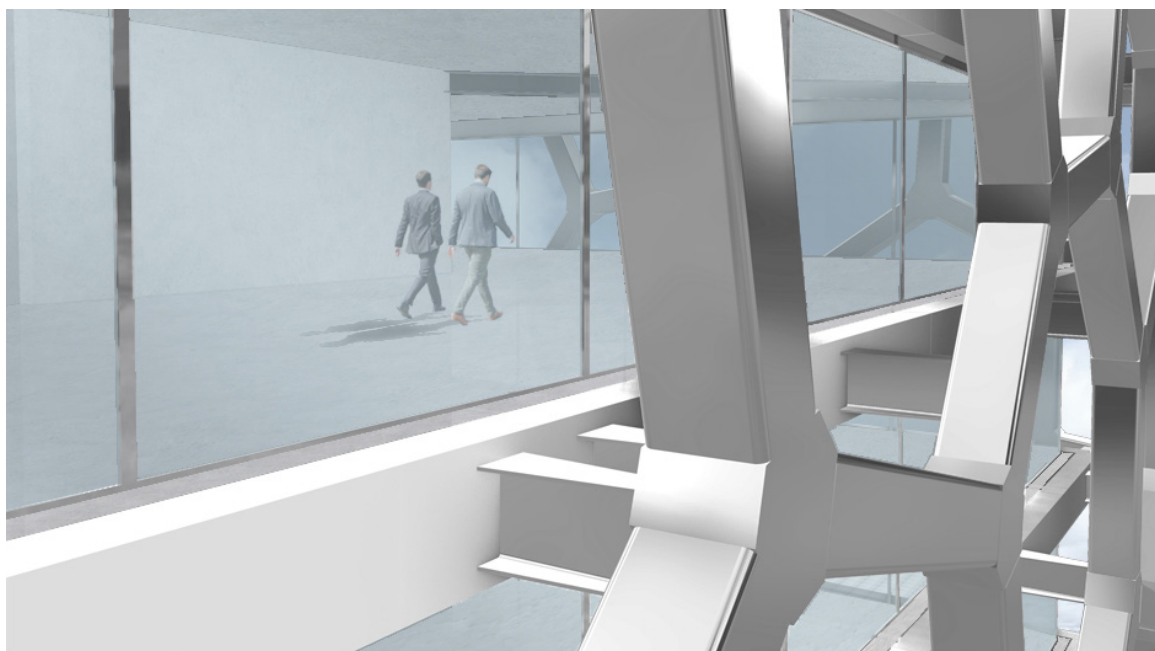

Rendered view of a Vorogrid tall building.

The influence of deflections on the static and dynamic behaviour of masonry columns

M. Girardi, C. Padovani, D. Pellegrini

European Journal of Mechanics A/Solids, vol. 94. Elsevier, 2022.

Masonry buildings are unable to withstand loads with large eccentricities. Ancient masonry constructions are mainly designed to constrain the compressive force inside the elements' section, while large tensile stresses are concentrated in the wooden and metallic parts. On the other hand, bending is always present in masonry elements. If the axial force is applied outside the central nucleus of inertia of a masonry beam, there is a reduction of the section's stiffness, and the behaviour of the beam becomes nonlinear. When deformation is considered in the equi-

librium equations, geometric and constitutive nonlinearities are coupled, and the effects of bending are consequently amplified. This paper studies the influence of bending deflections on the structural behaviour of masonry columns. Some explicit solutions are presented, and the combined effects of the constitutive and geometric nonlinearities are investigated through an iterative numerical procedure. The results show that considering second-order effects affects both the collapse load and the dynamical properties of masonry beams significantly.

DOI: 10.1016/j.euromechsol.2022.104570

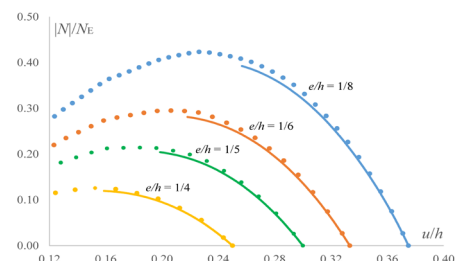

Case (a) : ratio $|N|/NEv$ ratio u/h for different values of the initial eccentricity e . From the left: $e/h = 1/4$, $e/h = 1/5$, $e/h = 1/6$, $e/h = 1/8$.

A semidefinite programming approach for the projection onto the cone of negative semidefinite symmetric tensors with applications to solid mechanics

C. Padovani, M. Porcelli

Calcolo, vol. 59. Springer, 2022.

We propose an algorithm for computing the projection of a symmetric second-order tensor onto the cone of negative semidefinite symmetric tensors with respect to the inner product defined by an assigned positive definite symmetric fourth-order tensor C . The projection problem is written as a semidefinite programming problem and an algorithm based on a primal-dual path-following interior point method coupled with a Mehrotra's predictor-corrector approach is proposed.

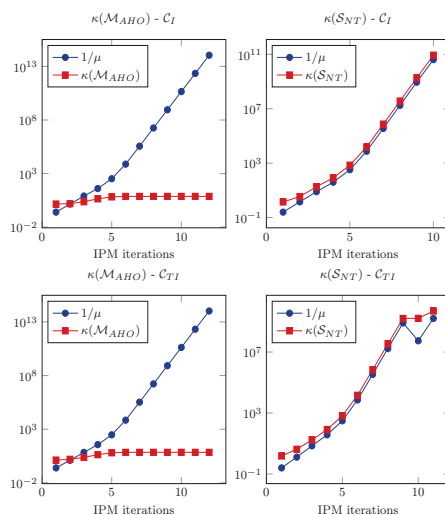

Temple D: condition number of S_{NT} and M_{AHO} along the interior point (IPM) iterations.

Implementations based on well-known symmetrization schemes and direct methods are theoretically and numerically investigated for tensors C arising in the modelling of masonry-like materials. For these special cases, indications on the preferable symmetrization scheme that take into account the conditioning of the arising linear systems are given.

DOI: 10.1007/s10092-022-00478-1

Using the space debris flux to assess the criticality of the environment in low Earth orbit

C. Pardini, L. Anselmo

Acta Astronautica, Vol. 198. Elsevier, 2022.

In this paper we introduce a new index for evaluating the likelihood of accidental collisions leading to the complete destruction of intact objects in a volume of space in low Earth orbit (LEO). The proposed index is therefore not intended to assess the criticality of individual objects or missions, but rather to estimate the global impact of space activities on a given region of space. Moreover, the new index has been designed to be objective, as simple as possible, built from easily accessible data, as well as smoothly reproducible by third parties. Named “volu-

metric collision rate index”, it has been developed starting from analytical equations expressing the collision rate as a function of the fluxes of intact objects and cataloged debris pieces. The application of reasonable simplifying assumptions and approximations has finally made it possible to define a dimensionless index that explicitly depends only on the spatial densities of intact objects and cataloged debris pieces. It has therefore been applied to the LEO environment, analyzing its evolution from mid-2008 to mid-2020, a crucial period characterized by

an impressive change of space activity patterns, with the launch of lots of small satellites and mega-constellations. We also discuss how the index can be further improved, taking into account the maneuverable satellites, which do not contribute to the collision rate, and the increasing number of cubesats, which in many respects are more similar to debris, finally presenting a preliminary analysis in this direction.

DOI: 10.1016/j.actaastro.2022.05.045

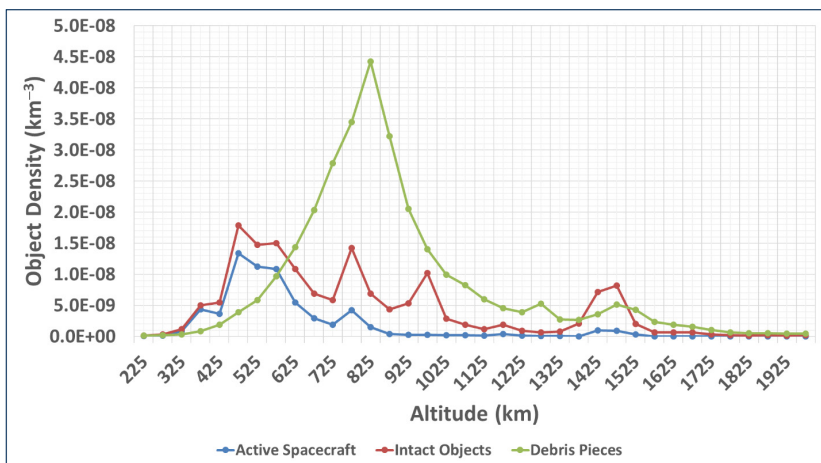

Distribution in low Earth orbit, in mid-2020, of active satellites, intact objects (spacecraft + rocket bodies) and cataloged debris pieces (breakup fragments + mission related objects).

Comparison of the volumetric collision rate index in low Earth orbit, averaged over 50 km altitude bins, in 2008 and 2020, in the latter case with and without the inclusion of active satellites.

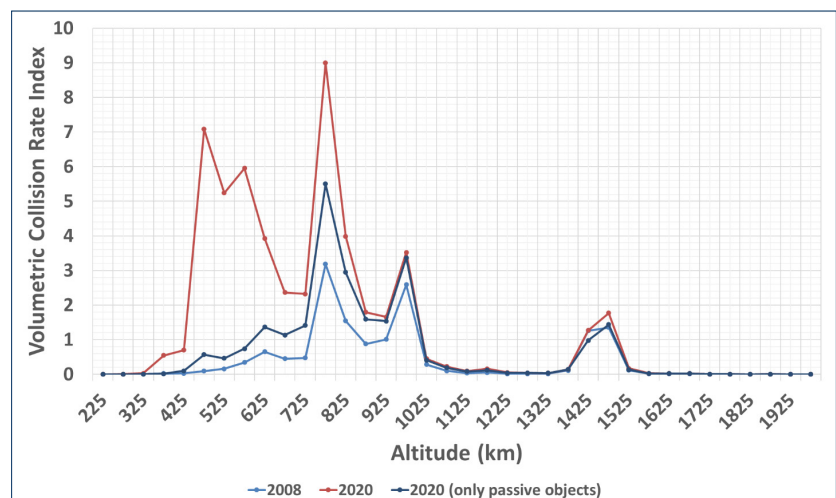

CATLib

A Library to Build Applications Exploiting Contract Automata.

Contract automata facilitate the specification, composition, and synthesis of behavioural contracts, comprehending modalities and configurations. Behavioural contracts have been introduced to specify the behaviour of services and to synthesise service compositions satisfying given formal properties. This allows rigorous reasoning on the composite behaviour, as well as improving the modularity, adaptability, and reusability of services. Contract automata are a dialect of Finite State Automata introduced to model behavioural service contracts in terms of service offer actions and service request actions, which need to match to achieve agreement among a composition of contracts. Modalities are used to indicate when an action must be matched (necessary) and when it can be withdrawn (permitted) in the synthesised composition. Composing contracts and synthesising a well-behaving composition,

usually by refining a spurious composition, are two of the main functionalities supported by contract automata. The synthesis for contract automata builds upon results from supervisory control theory for synthesising the most permissive controller, duly revisited for synthesising orchestrations and choreographies.

Contract automata are supported by a software API called Contract Automata Library (CATLib). This software artefact has been published as an original software publication by Davide Basile and Maurice ter Beek in Science of Computer Programming, volume 221 (2022), <https://doi.org/10.1016/j.scico.2022.102841>. This paper accompanies the open-source software artefact by discussing its architecture, showing some usage examples and presenting recent improvements of the software in terms of qual-

ity, availability, usability, and documentation. The purpose of the software is to show the feasibility of the proposed theoretical approach, to aid researchers experimenting with new developments in the theoretical framework of contract automata, and to build applications and formal tools exploiting this framework. A developer can exploit CATLib to instantiate contract automata and perform operations like composition and synthesis. An application developed with CATLib is thus formally validated by construction against well-behaving properties from the theory of contract automata.

Contact: Davide Basile, FMT Lab
davide.basile@isti.cnr.it

Contract Automata Library

A snapshot taken from <https://github.com/contractautomataproject/ContractAutomataLib>, 9 January 2023, showing the GitHub Badges of the open source repository hosting the Contract Automata Library. These badges show, among the others, data about the coverage of both unit testing and mutation testing, the grade provided by different services, the license.

FTS4VMC

A Front-end Tool for Static Analysis and Family-based Model Checking of Featured Transition Systems with the VMC Model-checking Tool.

FTS4VMC is a publicly available front-end tool for VMC, which is a model checker for behavioural variability models that is developed and maintained by the FMT lab at ISTI-CNR.

FTS4VMC enables the static analysis and family-based model checking of a Featured Transition System (FTS), which is a formalism for capturing variability in behavioural models of product families or configurable systems. FTS4VMC allows a user to (1) detect ambiguities in an FTS; (2) disambiguate an ambiguous FTS (i.e., an FTS with dead or false optional transitions or with hidden

deadlock states); (3) transform an FTS into a so-called Modal Transition System (MTS), which is the input model of VMC; and (4) interact with the VMC model checker for family-based verification.

To conclude, FTS4VMC automates the engineering and verification methodology envisioned in the figure below, thus expanding the possible use cases of the VMC to include also FTSs, offering moreover a significant gain in efficiency in specific cases, as demonstrated in Maurice ter Beek, Ferruccio Damiani, Michael Lienhardt, Franco Mazzanti, and Luca Paolini, "Efficient static analysis and

verification of featured transition systems", *Empir. Softw. Eng.* 22,1 (2022), <https://doi.org/10.1007/s10664-020-09930-8>.

This software artefact has been published as an original software publication by Maurice ter Beek, Ferruccio Damiani, Michael Lienhardt, Franco Mazzanti, Luca Paolini, and Giordano Scarso in *Science of Computer Programming*, volume 224 (2022), <https://doi.org/10.1016/j.scico.2022.102879>.

Contact: Maurice ter Beek, FMT Lab
maurice.terbeek@isti.cnr.it

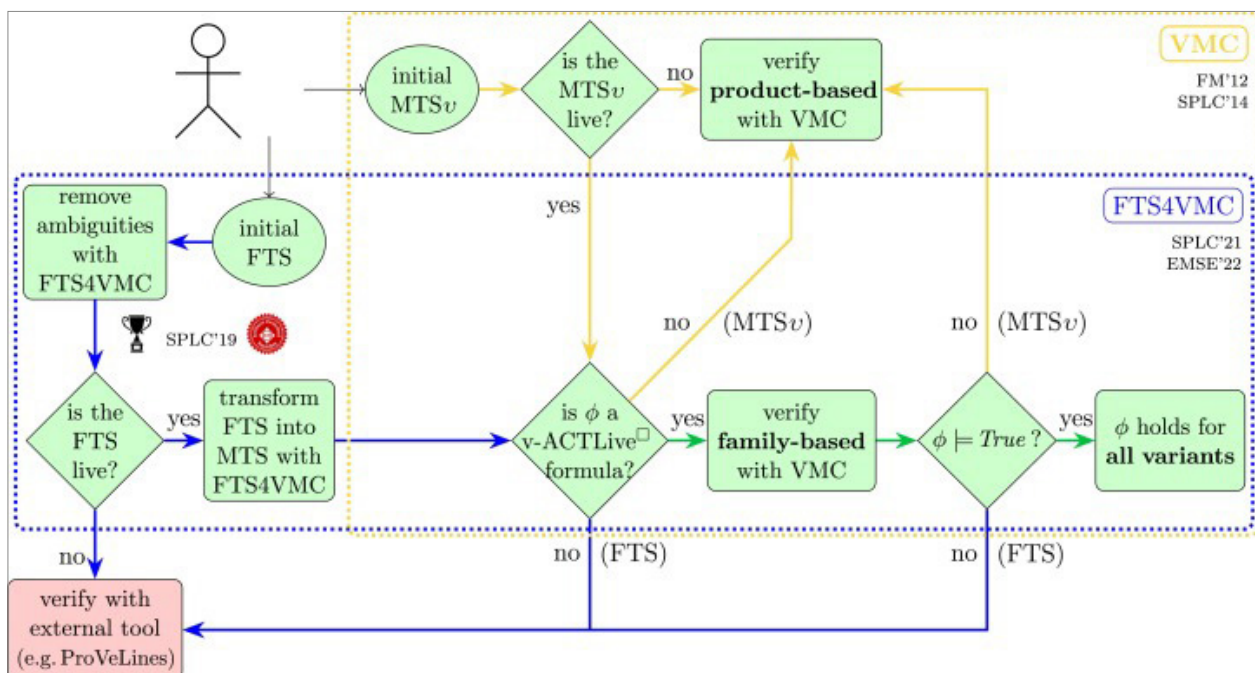

Engineering and verification methodology from ter Beek et al., "Static Analysis and Family-based Model Checking of Featured Transition Systems with VMC", *Proceedings of 25th International Systems and Software Product Line Conference (SPLC'21)*, vol. 2, ACM, <https://dx.doi.org/10.1145/3461002.3473071>.

Cor Baayen Young Researcher Award 2022

Fabio Carrara, 32, from ISTI-CNR, has been selected as the winner of the 2022 ERCIM Cor Baayen Young Researcher Award. The Cor Baayen Award, created in 1995 to honour the first ERCIM president, is an annual award given to a promising young researcher in computer science and applied mathematics.

Fabio Carrara is currently employed at the Information Science and Technologies Institute, National Research Council (ISTI-CNR). He obtained his Ph.D. in 2019 from the University of Pisa, Italy with the thesis titled "Deep Learning for Image Classification and Retrieval: Analysis and Solutions to Current Limitations" supervised by Giuseppe Amato, Claudio Gennaro, and Francesco Marcelloni.

Fabio's research focuses mainly on deep learning for multimedia understanding, representation, and retrieval. Over the years, he has contributed to these areas of research from a theoretical and an applied perspective.

His professional experience encompasses collaborations with national and international institutions, such as the Masaryk University (Czech Republic), Scuola Normale Superiore (Italy), Institute for Systems and Robotics (Portugal), and several Italian CNR institutes (IN-CNR, ILC-CNR, IIT-CNR). Fabio has been involved in several European and Italian research projects (e.g., AI4Media, CNR4C-AIMAP, ADA, Smart News).

He has published more than 40 papers in international journals (e.g., Medical Image Analysis, IEEE TIP, Computer Vision and Image Understanding, Information Systems, Information Processing & Management, Multimedia Tools and Applications, Expert Systems with Applications) and conferences in the areas of deep learning, computer vision, and multimedia information retrieval. He is an active member of the scientific community, and he has a good track record as a reviewer of international conferences and journals.

In 2018 he won the ISTI Young Research Award for best young (under 32 years) researcher.

Fabio's research activity stands out for its quality and interdisciplinarity. Worthy of note is his work on adversarial attack detection, proposing solutions based on the analysis of the features extracted by the various layers of deep neural networks. He also researched the application of appropriately simplified deep neural networks on resource-constrained devices, such as smart cameras. His research results are not only theoretical but also have high potential in multiple application domains, as for example, the miniaturised models for parking occupancy detection (<http://cnrpark.it/>) and for real-time pupillometry (<https://www.pupillometry.it>).

Contact: Fabio Carrara, AIMH Lab
fabio.carrara@isti.cnr.it



Fabio Carrara (Cnr-Isti, on the left) and Björn Levin (ERCIM President, on the right)

New Chair of the IADC Working Group on Environment and Data Base

Carmen Pardini appointed at the 40th IADC Plenary Meeting

After serving as Deputy Chair of Working Group 2 on Environment and Data Base of the Inter-Agency Space Debris Coordination Committee (IADC) since April 2020, Carmen Pardini was appointed as Chair for a two-year term at the 40th IADC Plenary Meeting, held in a hybrid format on Jeju Island, South Korea, from 10 to 14 October 2022.

The IADC is the main international governmental forum for the worldwide coordination of activities related to issues of human-made and natural debris in space. Currently consisting of 13 space agencies, the primary purpose of the IADC is to exchange technical information on space debris research activities, to facilitate opportunities for cooperation in space debris research, to review the

progress of ongoing cooperative activities, and to identify debris mitigation options. It also plays a prominent role in advising the international community, providing advice for instance to the Committee on the Peaceful Uses of Outer Space (COPUOS) of the United Nations.

In her new position, Carmen, a staff researcher of the Space Flight Dynamics Laboratory of ISTI, will coordinate the activities of Working Group 2 during a period characterized by great changes in space activities and new challenges in debris mitigation.

Contact: Carmen Pardini, SFD Lab
carmen.pardini@isti.cnr.it
<https://www.iadc-home.org/>



New IAA Full Member

Carmen Pardini elected for Engineering Sciences

In July 2022, Carmen Pardini was elected Full Member of the International Academy of Astronautics (IAA) for Section 2 – Engineering Sciences. Pardini had been IAA Corresponding Member since July 2018. The International Academy of Astronautics, founded in Stockholm, Sweden, on 16 August 1960, is an independent organization of distinguished individuals elected by their peers for their outstanding contributions to astronautics and space exploration. It promotes the development of astronautics for

peaceful purposes and works closely with the International Astronautical Federation and with national and international space agencies.

Carmen, a staff researcher of the Space Flight Dynamics Laboratory of ISTI, was nominated and elected Full Member of the Academy in recognition of the continuation of activities in space debris modeling and mitigation, as well as in reentry predictions of uncontrolled and potentially risky space

objects. Her active involvement in several international committees and working groups on these subjects was also recognized.

Contact: Carmen Pardini, SFD Lab
carmen.pardini@isti.cnr.it
<https://iaaspace.org/>

IAA Academy Day

International Academy of Astronautics (IAA) Academy Day, July 16, 2022, Academy of Athens – Athens, Greece

Carmen Pardini, a researcher of the Space Flight Dynamics Laboratory and Vice-Chair of the Panel PEDAS (Potentially Environmentally Detrimental Activities in Space) of the Committee on Space Research (COSPAR) since July 2018, was invited lecturer at the Academy Day of the International Academy of Astronautics (IAA), held at the Academy of Athens on Saturday, July 16, 2022, on the occasion of the 44th COSPAR Scientific Assembly.

The purpose of the invited lecture, entitled: "Space Debris: Issues and Concerns", was

to highlight space debris activities in the context of the PEDAS Panel, and to address the ever increasing concerns about space debris, and the urgent need to mitigate this problem. Space debris has become a major problem for all current and future space activities.

Compliance with regulations is of paramount importance to ensure the sustainability of the space environment, in both short and long term, in this new era where outer space is attracting so many actors. The conditions that have arisen require the collective effort

of all stakeholders, both public and private, at national and international level, to ensure the sustainability of space activities in outer space now and in the future.

Contact: Carmen Pardini, SFD Lab

carmen.pardini@isti.cnr.it

<https://iaaspace.org/iaa-academy-day-in-athens/>

The blind prediction challenge within the framework of the SERA project

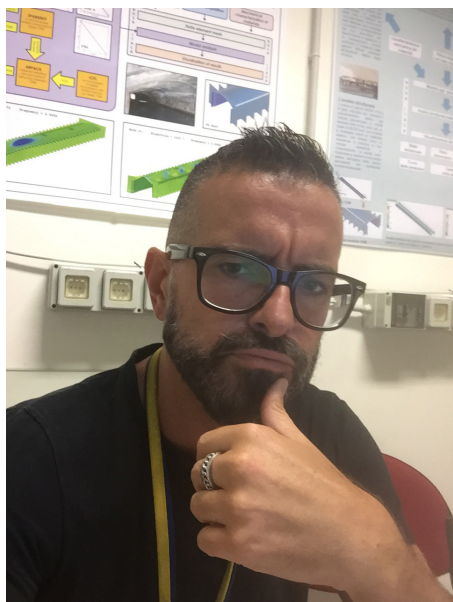

Daniele Pellegrini is the winner of the blind prediction challenge with the title "Blind prediction of a shake table test on a full-scale masonry cross vault without and with the application of the retrofitting" organised within the framework of the SERA project (Seismology and Earthquake Engineering Research Infrastructure Alliance for Europe; Reference:730900 - SERA Call: H2020-INFRAIA-2016-1).

The scope of the blind prediction is to assess the capability of different analysis approaches to predict by numerical model the seismic response of a 1:1 scale model of a brick unreinforced/reinforced masonry cross vault realised in the laboratory. For this purpose, a numerical model of the vault has been cre-

ated by NOSA-ITACA, a code developed by MMS Lab to analyse and calibrate masonry structures.

A refined finite-element model consisting of about 90000 elements with 30000 nodes has been built for a total of 90000 degrees of freedom. Through the execution of nonlinear static and dynamic analyses, it was possible to predict the vault response in terms of damage, displacement capacity, and peak acceleration.

Contact: Daniele Pellegrini, MMS Lab

daniele.pellegrini@isti.cnr.it

<http://www.nosaitaca.it/category/tipologia/news/>

Young Researcher award “Matteo Dellepiane” 2022

The ISTI Young Researcher Award (YRA) “Matteo Dellepiane” is an annual award that honors its staff of less than 35 years old for a distinct contribute to the Institute activity with their scientific production.

There are two categories:

- Young Researcher - Beginner - awarded to researchers less than 32 years old;

- Young Researcher - Advanced - awarded to Ph.D. students and Ph.D. researchers less than 35 years old.

Contact: Franco Maria Nardini, HPC Lab
francomaria.nardini@isti.cnr.it

Beginner



Salvatore Citraro

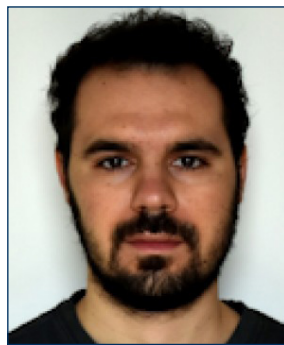

Nicola Messina



Giulio Ermanno Pibiri

Advanced



Antonino Crivello



Luigi Malomo



Lucia Vadicamo

Grants for Young Mobility

The ISTI Grants for Young Mobility (GYM) program enables young researchers (under 34) to carry out research in cooperation with foreign Universities and Research Institutions of clear international stand-

ing. It complements similar CNR programs.

The winners in 2022 are :

Contact: **Franco Maria Nardini, HPC Lab**
francomaria.nardini@isti.cnr.it

First Call 2022



Rossana Buongiorno

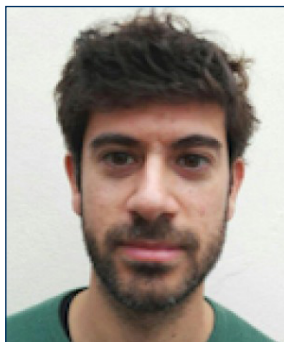

Luca Ciampi



Francesco Conti



Nicola Messina

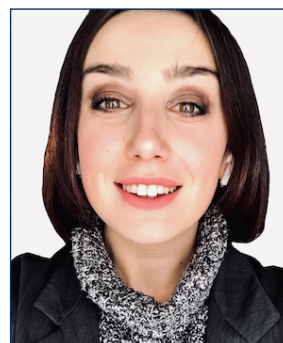

Valentina Pansanella

Second Call 2022

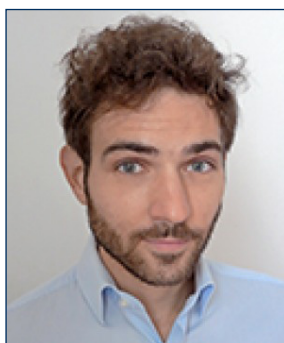

Francesco Laccone



Virginia Morini



Alberto Veneri

Conferences - Co-organized by ISTI



11th International Workshop on Computational Intelligence for Multimedia Understanding (IWCIM)
4 - 9, June 2023, Rhodes Island,

<https://iwcim.itu.edu.tr/>



9th International Symposium on End-User Development (IS-EUD 2023)
06-08 June 2023, Cagliari, Italy

<https://cg3hci.dmi.unica.it/iseud2023/>



27th ACM International Systems and Software Product Line Conference (SPLC 2023)
28 August - 1 September 2023, Tokyo, Japan

<https://2023.splc.net/>



17th International Workshop on Advanced Infrared Technology and Applications (AITA)
10-13 September 2023, Venice, Italy

<http://aita.isti.cnr.it/>



18th Conference on Computer
Science and Intelligence Systems

FedCSIS 2023
Warsaw - Poland
17-20 September

1st Workshop on AI in Agriculture (AgriAI'23)
17-20, September 2023, Warsaw, Poland

<https://fedcsis.org/sessions/aaia/agriai>



ISTI News is published by the Institute of Information Science and Technologies "A. Faedo"
National Research Council
Via G. Moruzzi 1-56124 Pisa Italy
<http://www.isti.cnr.it>

ISSN: 2724-6566
DOI: 10.32079/ISTINews

Editorial Secretariat

segreteria scientifica@isti.cnr.it

Editorial Board

Fabrizio Falchi
Silvia Giannini
Carol Peters
Claudia Raviolo
Roberto Scopigno

Layout and Design

Salvatore Rinzivillo, Daniele Fadda, Beatrice Rapisarda

Copyright notice

All authors, as identified in each article, retain copyright of their work.
The authors are responsible for the technical and scientific contents of their work

Privacy statement

The personal data (names, email addresses...) and the other information entered in ISTI News will be treated according with the provision set out in Legislative Degree 196/2003 (known as Privacy Code) and subsequently integration and amendment

Legal representative of the Institute of Information Science and Technologies "A. Faedo": Dott. Roberto Scopigno

ISTI News is not for sale but is distributed for purposes of study and research and published online at
<https://www.isti.cnr.it/en/isti-news>

To subscribe: send your email to istinews@isti.cnr.it